

# Operation and Maintenance Manual

## Electronic Laboratory Autoclaves Models 5050, 5075 EL-MD/EL-D

*First time published; 06.06.2016*

---

**EL-MD:** standard autoclave (manual door)

**EL-D:** standard autoclave (automatic door)

**C:** optional system for fast cooling

**PV:** optional vacuum pump

**BH:** optional bio hazard filtration

**F:** optional fan for super-fast cooling

---

Cat. No. MAN205-0469001EN Rev I

---

☒ Heidolph North America, 1241 Jarvis Ave. Elk Grove Village IL, ☎ Phone:  
224-265-9600 ☒ Fax: 224-265-9611, e-mail: sales@heidolph.com

☒ Brinkmann Instruments (Canada) Ltd. 4160 Sladeview Crescent #6,  
Mississauga, Ontario L5N 2L8, ☎ (905) 569-0664, Toll Free: (866) 260-6069,  
☒ Fax: (905) 569-0665



**TABLE OF CONTENT**

	<b>PARAGRAPH</b>	<b>PAGE NO.</b>
<b>1</b>	<b>GENERAL .....</b>	<b>5</b>
	1.1 <i>Introduction.....</i>	<i>5</i>
	1.2 <i>Incoming Inspection .....</i>	<i>6</i>
	1.1 <i>Warranty Statement .....</i>	<i>7</i>
	1.2 <i>Ordering Information .....</i>	<i>8</i>
	1.3 <i>Accessories.....</i>	<i>8</i>
<b>2</b>	<b>SAFETY INSTRUCTIONS.....</b>	<b>10</b>
<b>3</b>	<b>TECHNICAL DATA.....</b>	<b>12</b>
	3.1 <i>Directives and Standards .....</i>	<i>12</i>
	3.2 <i>Water quality .....</i>	<i>12</i>
	3.3 <i>Electrical Data .....</i>	<i>14</i>
	3.4 <i>Stand – by heating mode.....</i>	<i>14</i>
	3.5 <i>Operating Conditions.....</i>	<i>14</i>
	3.6 <i>Utilities.....</i>	<i>15</i>
	3.7 <i>Load on counter .....</i>	<i>15</i>
	3.8 <i>Construction.....</i>	<i>16</i>
	3.9 <i>Environment Emission Information .....</i>	<i>16</i>
	3.10 <i>Overall Dimensions -- EL5050-MD/ EL5050-D.....</i>	<i>17</i>
	3.11 <i>Overall Dimensions -- ELCPV 5050-MD/ ELCPV 5050-D .....</i>	<i>18</i>
	3.12 <i>Overall Dimensions -- ELPRC 5075-MD/ ELPRC 5075-MD .....</i>	<i>19</i>
	3.13 <i>Specifications.....</i>	<i>20</i>
	3.14 <i>Symbol Description .....</i>	<i>21</i>
<b>4</b>	<b>CONTROL PANEL .....</b>	<b>24</b>
	4.1 <b>CONTROL PANEL DRAWING .....</b>	<b>24</b>
	4.2 <i>Description and Functions of the Front Panel Keyboard .....</i>	<i>25</i>
	4.3 <i>Displayed Error Messages / Symbols .....</i>	<i>27</i>
	4.4 <i>Displayed operational messages / Symbols .....</i>	<i>27</i>
<b>5</b>	<b>Sterilization Programs .....</b>	<b>29</b>
	5.1 <i>Program 1: Glass .....</i>	<i>32</i>
	5.2 <i>Program 2: Plastic.....</i>	<i>33</i>
	5.3 <i>Program 3: Liquid A .....</i>	<i>34</i>
	5.4 <i>Program 4: Liquid B – Waste.....</i>	<i>35</i>
	5.5 <i>Program 5: Liquid A – Cooling (C – cooling models only) .....</i>	<i>36</i>
	5.6 <i>Program 6: Liquid B – Waste Cooling (C – cooling models only).....</i>	<i>37</i>
	5.7 <i>Program 7: Bio Hazard 1 (BH, bio-hazard models only) .....</i>	<i>38</i>
	5.8 <i>Program 8: Bio Hazard 2 (BH, bio-hazard models only) .....</i>	<i>39</i>
	5.9 <i>Program 9: Bio Hazard Liquids (BH, bio-hazard models only)..</i>	<i>40</i>
	5.10 <i>Program 10: Vacuum Test (PV, pre-vacuum models only) .....</i>	<i>41</i>
	5.11 <i>Program 11: Warm-Up .....</i>	<i>42</i>

	5.12 Program 12: Isothermal .....	43
	5.13 Program 13: Air Mixture.....	44
	5.14 Program 14: Glass Test .....	45
	5.15 Program 15: Durham.....	46
6	<b>SCREENS.....</b>	<b>48</b>
	6.1 Screens following a completely successful cycle – "Cycle Ended" .....	48
	6.2 Screens following aborted cycles after complete sterilization stage .....	49
	6.3 Screens following a fail cycle: .....	49
7	<b>Checking and Changing Parameters and other data .....</b>	<b>51</b>
	7.1 Browsing through the menus.....	51
	7.2 Changing a Parameter .....	52
	7.3 Quick options screen.....	54
	7.4 Logging in and entering the Main menu .....	58
	7.5 Changing parameters .....	60
	7.6 System Parameters .....	61
	7.7 Maintenance .....	61
	7.8 Cycle parameters .....	63
8	<b>PRINTER .....</b>	<b>65</b>
	8.1 Printer Output.....	65
	8.2 Printer Handling .....	67
	8.3 Treating the thermal papers: .....	69
9	<b>PREPARATION BEFORE STERILIZATION .....</b>	<b>70</b>
	9.1 Instruments .....	70
	9.2 Tubing.....	71
	9.3 Sterilization of Liquids.....	72
	9.4 Filling the Water Reservoir.....	72
10	<b>OPERATING INSTRUCTIONS.....</b>	<b>74</b>
	10.1 Turning on the autoclave.....	74
	10.2 Opening the door – MD models (mechanical door) .....	74
	10.3 Opening the door – D models (automatic door).....	74
	10.4 Safety.....	75
	10.5 Loading.....	76
	10.6 Selecting the Program .....	76
	10.7 Closing the door – MD models (mechanical door).....	76
	10.8 Closing and locking the door – D models (automatic door).....	76
	10.9 Starting cycle .....	77
	10.10 Unloading.....	78
	10.11 Start Cycle by Clock mode.....	79
11	<b>SERVICE AND MAINTENANCE INSTRUCTIONS.....</b>	<b>80</b>
	11.1 Preventive and Scheduled Maintenance.....	80

---

11.2	<i>Draining the Reservoir</i> .....	81
11.3	<i>Cleaning water strainer</i> .....	82
11.4	<i>Checking the Safety Valve</i> .....	83
11.5	<i>Moving the Autoclave</i> .....	85
12	<i>Safety Process Description</i> .....	86
12.1	<i>DOOR SAFETY SYSTEM – D models (automatic door)</i> .....	86
12.2	<i>DOOR SAFETY SYSTEM – MD models (mechanic door)</i> .....	86
12.3	<i>Pressure switch</i> .....	87
13	<i>TROUBLESHOOTING</i> .....	88
14	<i>SPARE PARTS LIST</i> .....	93
15	<i>ACCESSORIES LIST</i> .....	93

---

**TABLE OF CONTENT (Cont.)**

<b>DRAWINGS</b>	<b>PAGE NO.</b>
<i>FRONT VIEW</i> .....	<i>22</i>
<i>REAR VIEW</i> .....	<i>23</i>
<i>BASKETS AND CONTAINERS</i> .....	<i>92</i>

**1 GENERAL**



**Read the Operating Instructions carefully, before beginning any operation on the autoclave!**

**1.1**

**Introduction**

Model 5050/5075 EL-MD/EL-D is a laboratory sterilizer designed especially for the sterilization of instruments, liquids, and other materials in hospital laboratories, medical laboratories (including the medical waste), research institutes, food laboratories and pharmaceutical facilities.

MD models have a manual door with handle, and D models have an automatic door equipped with an electrical cylinder. The automatic door locks itself when closed and unlocks .by pressing a button.

The PV (pre-vacuum) models are equipped with a vacuum pump.

The advantages of the pre-vacuum sterilizer in comparison to the regular gravity displacement steam sterilizer are as follows:

- Removal of air pockets from packs and porous loads and most kinds of tubes (rubber, plastic etc.) by vacuum at the first stage of the cycle.
- Better steam penetration into the load; resulting in effective sterilization.
- Better temperature uniformity.
- Better drying of materials with closed doors due to the vacuum achieved in the chamber at the end of the sterilization cycle.

In BH (bio-hazard) models, a bio-hazard filter installed in the chamber enables sterilizing bio-hazard load without contaminating the surrounding.

There is a configuration equipped with fan that allows shortening the cooling operation.

The temperature and pressure are controlled through sensors placed inside and outside the media container or bottles.

The autoclave is equipped with A 9Kw generator that produces the steam required for the sterilization.

A special feature of the autoclave is fast cooling stage for liquids. In this stage pressure in the chamber is increased by means of compressed air to compensate the fast decreasing of pressure due to the fast cooling. The fast cooling shortens the time required for safe handling of bottles.

In BH (bio-hazard) models, a bio-hazard filter installed in the chamber enables sterilizing bio-hazard load without contaminating the surrounding.

A computerized control unit ensuring a fully automatic sterilization cycle controls the autoclave.

The temperature and pressure are controlled through sensors placed inside and outside the media container or bottles.

The sterilizer is fully automatic with a choice of 15 programs, eliminating any need for operator intervention during a cycle (programs 9-10 are for vacuum testing only). A computerized control unit enables precise control and monitoring of physical parameters and clear documentation of the sterilization cycles.

The autoclave is equipped with a safety valve, which will discharge at an overpressure of over 2.8 Bar (40 psi), which is located on the chamber near the pressure switch and the steam pressure gauge. The control system provides adequate protection, to ensure the safety of personnel and reliable operation with a minimum of down time.

The sterilizer has multiple built-in safety devices, which provides adequate protection to ensure the safety of operating personnel.

The printer prints the preset and actual parameters of the cycle (temperature, time and pressure).

The autoclave is provided with a pressure gauge that is used as guide only. Should there be a power failure during the operation of the autoclave, the pressure gauge indicates to the operator that there is pressure in the chamber.

A deviation of +1.6% is accepted.

**Note:** After operating the sterilizer, brown stains might appear on the bottom of the chamber. These stains are a result of the heating elements that are located at the lower external part of the chamber. The brown color is a common phenomenon, can easily be removed, and will not have any effect on the sterilized goods.

This manual is intended to give the user a general understanding of how the autoclave works and indicates the best ways to operate and take care of it in order to obtain optimum results and a trouble-free operation. After reading this manual, operating the autoclave should be straightforward. However, since the autoclave is built using high technology sensitive components, no attempt should be made by the user or any other unauthorized person to repair or recalibrate it.



**Only technical personnel having proper qualifications, holding technical documentation and adequate test instrumentation are authorized to undertake repair or service.**

## **1.2 Incoming Inspection**

The autoclave should be unpacked and inspected for mechanical damage upon receipt. Observe packing method and retain



packing materials until the unit has been inspected. Mechanical inspection involves checking for signs of physical damage such as: scratched panel surfaces, broken knobs, etc.

If damage is apparent, contact your dealer or point of purchase, so that they may notify the manufacturer and file a claim with the appropriate carrier.

All **Tuttnauer** products are carefully inspected prior to shipment and all reasonable precautions are taken in preparing them for shipment to assure safe arrival at their destination.

We certify that this instrument is guaranteed to be free from defects in material and workmanship for one year against faulty components and assembly with the exception of glassware, lamps and heaters.

**The warranty does not include and does not replace routine treatment and preventive maintenance to be performed according to instructions in sec. 12.1 (Preventive Maintenance).**

Our obligation is limited to replacing the instrument or parts, after our examination, if within one year after the date of shipment they prove to be defective. This warranty does not apply to any instrument that has been subjected to misuse, neglect, accident or improper installation or application, nor shall it extend to products that have been repaired or altered outside the factory without prior authorization from us.

**The Autoclave should not be used in a manner not described in this manual!**

### **1.3 Warranty Statement**

To activate your warranty or for warranty information on this unit please contact your dealer or Heidolph at one of the #'s listed below:

☒ Heidolph North America , 1241 Jarvis Ave. Elk Grove Village IL, ☎ Phone: 224-265-9600 ☐ Fax: 224-265-9611, e-mail: sales@heidolph.com

☒ Brinkmann Instruments (Canada) Ltd. 4160 Sladeview Crescent #6, Mississauga, Ontario L5N 2L8, ☎ (905) 569-0664, Toll Free: (866) 260-6069, ☐ Fax: (905) 569-0665

**Tuttnauer USA** Co., Ltd., 25 Power Drive Hauppauge, NY 11788, USA (800) 624 5836, (631) 737 4850, Fax: (631) 737 0720  
e-mail:info@tuttnauerUSA.com.

**Note:** If you have any questions or there are any difficulties with this instrument and the solution is not covered in this manual, please contact your dealer or Heidolph.

**Do not attempt to service this instrument yourself.**

If there is any difficulty with this instrument, and the solution is not covered in this manual, contact our representative or us first. Do not attempt to service this instrument yourself. Describe the difficulty as clearly as possible so we may be able to diagnose the problem and provide a prompt solution.

If the autoclave is equipped with a printer, send along a copy of the last printout for our inspection. If replacement parts are needed, stipulate the model and serial number of the machine.

No products will be accepted for repair without proper authorization from us. All transportation charges must be paid both ways by the owner. This warranty will be void if the unit is not purchased from an authorized full service **Tuttnauer** dealer.

**1.4 Ordering Information**

Several items must be specified when ordering the unit from your dealer.

- The chamber diameter and chamber depth required
- Please specify the supply voltage available (i.e. 115v/208v; 1Ph/3Ph)
- The temperature scale needed (Celsius or Fahrenheit).
- The pressure scale needed (kPa or psi)

**1.5 Accessories**

- Baskets – Different size baskets are available for these units. The baskets are made of stainless steel wire and have a handle. The basket allows the operator to load a large quantity of materials into the chamber.

The baskets are made of stainless steel wire and have a handle. The basket allows the operator to load a large quantity of materials into the chamber.

- Stainless steel containers - Different size containers are available for these units .

The containers are designed for sterilizing waste material. The containers have vent holes along the upper rim.

**Note:** If there is any difficulty with this instrument, and the solution is not covered in this manual, contact our representative or us first. Do not attempt to service this instrument yourself. Describe the difficulty as clearly as possible so we may be able to diagnose the problem and provide a prompt solution.

If the autoclave is equipped with a printer, send along a copy of the last printout for our inspection. If replacement parts are needed, stipulate the model and serial number of the machine.

No autoclaves will be accepted for repair without proper authorization from us. All transportation charges must be paid both ways by the owner. This warranty will be void if the unit is not purchased from an authorized full service **Tuttnauer** dealer.

---

## 2 SAFETY INSTRUCTIONS

The autoclave has unique characteristics. Please read and understand the operation instructions before first operation of the autoclave. The following issues may require instructions guidance provided by the manufacturer: how to operate the autoclave, the door safety mechanism, the dangers involved in circumventing safety means, how to ensure that the door is closed, and how to select a correct sterilization program.

Make sure that you know where the main power switch is, where the water cut-off valve is and where the steam and compressed air disconnection valves are located.

Autoclave maintenance is crucial for the correct and efficient function of the device. We enclose a log booklet that includes maintenance recommendations, with every device.

The weekly spore test is part of the preventive maintenance plan, along with the annual validation of the sterilization processes that ensures appropriate temperature dispersion within the chamber.

Never use the autoclave to sterilize corrosive products, such as: acids, bases and phenols, volatile compounds or solutions such ethanol, methanol or chloroform nor radioactive substances.

Never start using a new autoclave or a new steam generator, before the safety, licensing and authorization department has approved it for use.

All autoclave users must receive training in proper usage from an experienced employee. Every new employee must undergo a training period under an experienced employee.

A written procedure must be established for autoclave operation, including: daily safety tests, seal inspection and door hinge inspection, smooth action of the closing mechanism, chamber cleaning, prevention of clogging and preservation from corrosion, what is permitted and what is prohibited for sterilization and choosing a sterilization program.

Liquids may be sterilized only with the "liquids" program. The container must be covered but not sealed. Sealed bottles may only be sterilized using a special program. The bottle must be either Pyrex or a Borosilicate glass bottle.

When sterilizing plastic materials, make sure that the item can withstand sterilization temperature. Plastic that melts in the chamber is liable to cause a great deal of damage.

Individual glass bottles may be placed within an appropriate container that will be placed on a tray. Never place glass bottles on the floor of the autoclave. Never fill more than 2/3 of the bottle volume.

On closing the autoclave's door, make sure it is properly locked before activating.

Before withdrawing trays, wear heat resistant gloves.

Before opening the door, verify that there is no pressure in the chamber (chamber pressure gauge is located on the autoclave's front panel).

Open the door slowly to allow steam to escape and wait 5 minutes before you remove the load. When sterilizing liquids, wait 10 minutes.

Once a month, ensure that the safety valves are functioning, and once annually a certified tester must conduct pressure chamber safety tests.

Once annually, or more frequently, effective tests must be performed, i.e., calibration and validation.

Examine the condition of assemblies on a regular basis. Make sure there are no leaks, breaks, blockages, whistles or strange noises.

It is required to conduct maintenance operations as instructed.

Immediately notify the person in charge of any deviation or risk for the proper function of the device.

### 3 TECHNICAL DATA

#### 3.1 Directives and Standards

Every autoclave meets the provisions of the following Directives and is constructed in compliance with the following Standards:

Tuttnauer. Ltd. company meets the provisions of the following standards:

ISO 9001:2008 (Quality Systems)

Tuttnauer. Ltd. company also works in conjunction with and refers to:

**ANSI/AAMI ST55** American Society of Mechanical Engineers  
Section VIII, Division 1, for unfired pressure vessels.  
**EN 13060** Small Steam Sterilizers.  
**UL** UL 61010-1  
**PED** 97/23EEC  
**IEC** IEC 61010-2-040 Safety  
**ISO** 17665-1:2006 (Validation and Routine Control)

#### 3.2 Water quality

The distilled or mineral-free water supply shall be according to the table below:

**Physical Characteristics and Maximum acceptable contaminants levels in water or steam, for steam generator and sterilizers (According to EN 285: 2006)**

	Contaminants in water supplied to generator	Contaminants in condensate at steam inlet to sterilizer
Evaporate residue	≤ 10 mg/l	N/A
Silicate (SiO <sub>2</sub> )	≤ 1 mg/l	≤ 0.1 mg/l
Iron	≤ 0.2mg/l	≤ 0.1mg/l
Cadmium	≤ 0.005 mg/l	≤ 0.005 mg/l
Lead	≤ 0.05 mg/l	≤ 0.05 mg/l
Rest of heavy metals except iron, cadmium, lead	≤ 0.1 mg/l	≤ 0.1 mg/l
Chloride (Cl)	≤ 2 mg/l	≤ 0.1 mg/l
Phosphate (P <sub>2</sub> O <sub>5</sub> )	≤ 0.5 mg/l	≤ 0.1 mg/l
Conductivity (at 25°C)	≤5 µs/cm	≤ 3 µs/cm
pH value (degree of acidity)	5 to 7.5	5 to 7

<b>Hardness (<math>\Sigma</math> ions of alkaline earth)</b>	$\leq 0.02$ mmol/l	$\leq 0.02$ mmol/l
<b>Appearance</b>	Colorless, clean, without sediments	
[Minimum specific resistivity of 1 megohm per cm (1 M $\Omega$ /cm)]		

Compliance with the above data should be tested in accordance with acknowledged analytical methods, by an authorized laboratory.

**Attention:**

The use of water for autoclaves that do not comply with the table above may have severe impact on the working life of the sterilizer and can invalidate the manufacturer's guarantee.

**Use Only deionized water, Having a maximum conductance of 1 microSiemen per cm (1  $\mu$ S/cm) Tap Water supply**

Maximum hardness value 0.7-2.0 mmol/l

The use of soft water is strictly forbidden!

Please consult a water specialist!

**Reverse Osmosis**

A Reverse Osmosis (RO) system may be used to improve the quality of the water used to generate steam in the autoclave chamber.

In RO, the water is forced through a semi-penetrable membrane, which filters out contaminants to a high degree of efficiency. In deionisation (DI) ions and charged particles are removed either by electric fields or by ion exchange in resin beds.

Although the RO cannot normally attain the degree of purity possible with the DI methods, it is more than adequate for the feed water intended for clean-steam generators.

Moreover the RO has several advantages:

1. RO is cheaper to install and to run than DI.
2. RO removes particulate matter, organic molecules and pyrogens that DI cannot remove
3. RO water is less corrosive to steel and copper than DI water.
4. RO maintenance requirements are less demanding than those of the DI units.

Therefore the use of mineral free water will contribute to better performance and longer life of the autoclave.

### 3.3 **Electrical Data**

#### 230V configuration

Property	Value: 5050	Value: 5075
Total Power	4400 (4*1100)	6600 (6*1100)
Voltage	1Ph, 230VAC	1Ph, 230VAC
Amperage	16	16
Protection against electrical shock	Class I (IEC 60601-1)	
Mains supply fluctuation	+/- 10%	
Degree of protection by enclosure	IP31	

#### 400V configuration

Property	Value: 5050	Value: 5075
Total Power	4400 (4*1100)	6600 (6*1100)
Voltage	3Ph, 400VAC	3Ph, 400VAC
Amperage	10	10
Protection against electrical shock	Class I (IEC 60601-1)	
Mains supply fluctuation	+/- 10%	
Degree of protection by enclosure	IP31	

#### 3.4 **Stand – by heating mode**

The autoclave provides an option of heating the chamber in stand-by mode between cycles with a very low power in order to reduce total cycle time (1.6% of the total power only). The autoclave turns off automatically if the **interval between the sterilization cycles is more than 2 hours**.

#### 3.5 **Operating Conditions**

**This device is for indoor use only!**

**The sterilizer should be loaded only with autoclavable material!**

**The environment shall not exceed an ambient temperature of 40°C and a relative humidity of 85% respectively.**



- ◆ The operation altitude shall not be over 2000 meters (6561 feet) (ambient pressure shall not be lower than 80 kPa (11.6 psi)).
- ◆ The autoclave shall not be used in a manner not specified in this manual!
- ◆ Do not use the autoclave in the presence of dangerous gases.
- ◆ The packed or unpacked device shall be stored in 'indoor' conditions.

Operate the autoclave only in the manner specified in the manual. If the equipment is used in a manner not specified by the manufacturer, the protection provided by the equipment may be impaired.

**Caution!**



**Waste water should be brought into the public net in accordance with the local rules or requirements i.e ONLY NON-HAZARDOUS LIQUIDS SHALL BE DISPOSED IN PUBLIC SEWAGE!**

**3.6 Utilities**

<b>Compressed Air (C models only)</b>	1/2" 2-5 Bar
<b>Tap water (C models only)</b>	1/2", 2-5 Bar
<b>Drain (C models only)</b>	Withstanding temp. of 80°C

<b>Model</b>	<b>Power consumption</b>	<b>Supply Voltage</b>	<b>Line current</b>	<b>Protection against electrical shock</b>
<b>5075</b>	6 x 1100W	3 Ph, 400V/50Hz	10A	Class I (IEC 60601-1)
<b>5050</b>	4 x 1100W	3 Ph, 400V/50Hz	10A	Class I (IEC 60601-1)



**Attention:**

The electrical net must be protected with a current leakage safety relay.  
The electrical network must comply with local rules or regulations.

**3.7 Load on counter**

The counter (or shelve, etc.) on which the autoclave shall be placed must be able to withstand, at least, the following weight:

---

<b>Model</b>	5050	5075
<b>Weight</b>	285 kg	310 kg

**3.8 Construction**

The main parts of the autoclave are made of materials as indicated below:

- ◆ Chamber and door are made of stainless steel
- ◆ Trays are made of stainless steel.
- ◆ Water reservoirs are made of stainless steel.
- ◆ Door handle (MD models) is made of hard plastic material, which is safe to touch and thermo-insulated.

**3.9 Environment Emission Information**

1. The peak sound level generated by the autoclave is less than 70 dBa with background noise of 60 dBa.
2. The total heat per hour transmitted by the autoclave is < 440 W/h for all models.

**3.10 Overall Dimensions -- EL5050-MD/ EL5050-D**

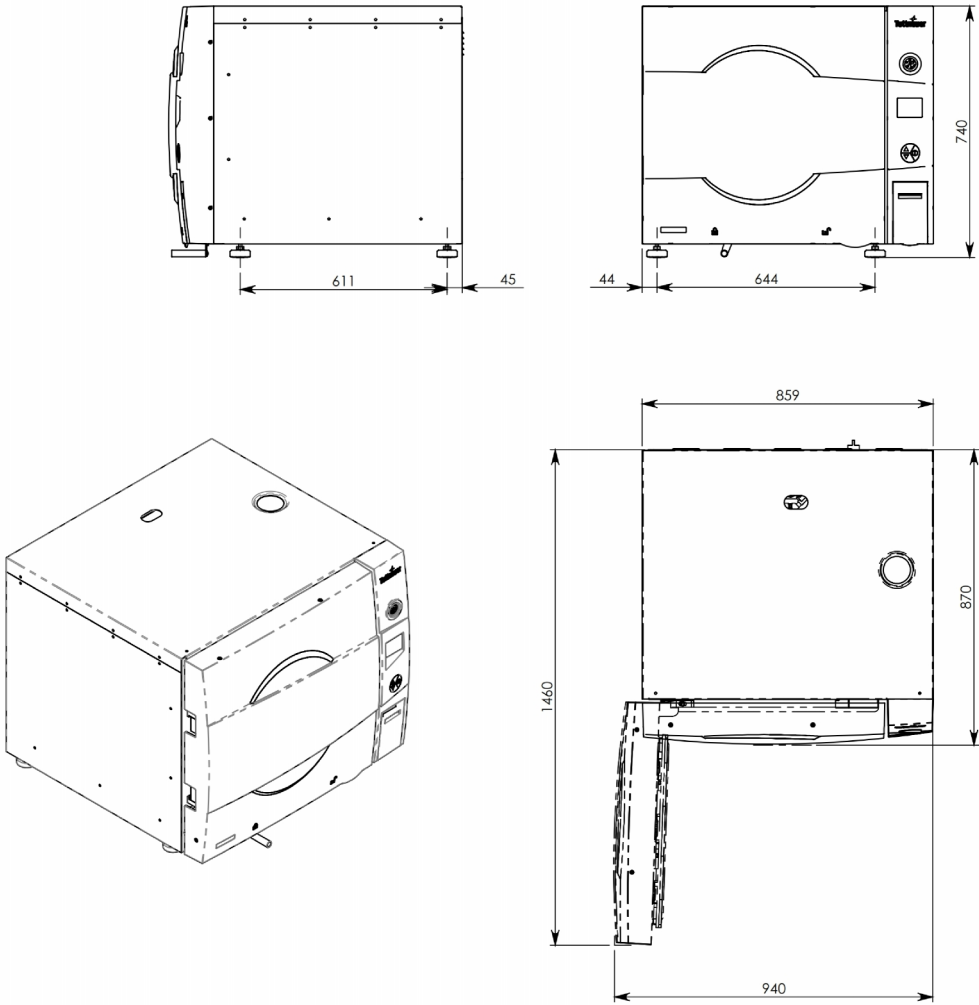

**3.11 Overall Dimensions -- ELCPV 5050-MD/ ELCPV 5050-D**

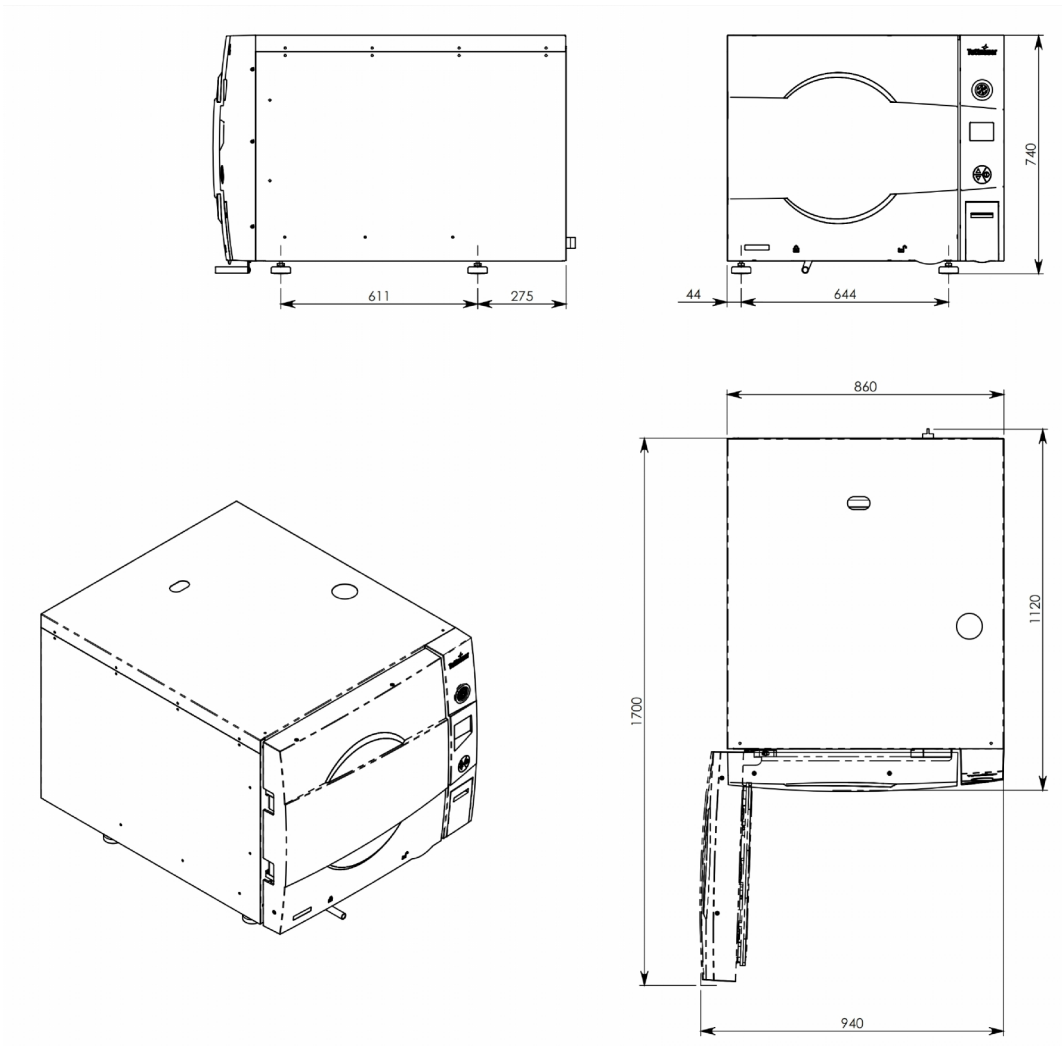

**3.12 Overall Dimensions -- ELPRC 5075-MD/ ELPRC 5075-MD**

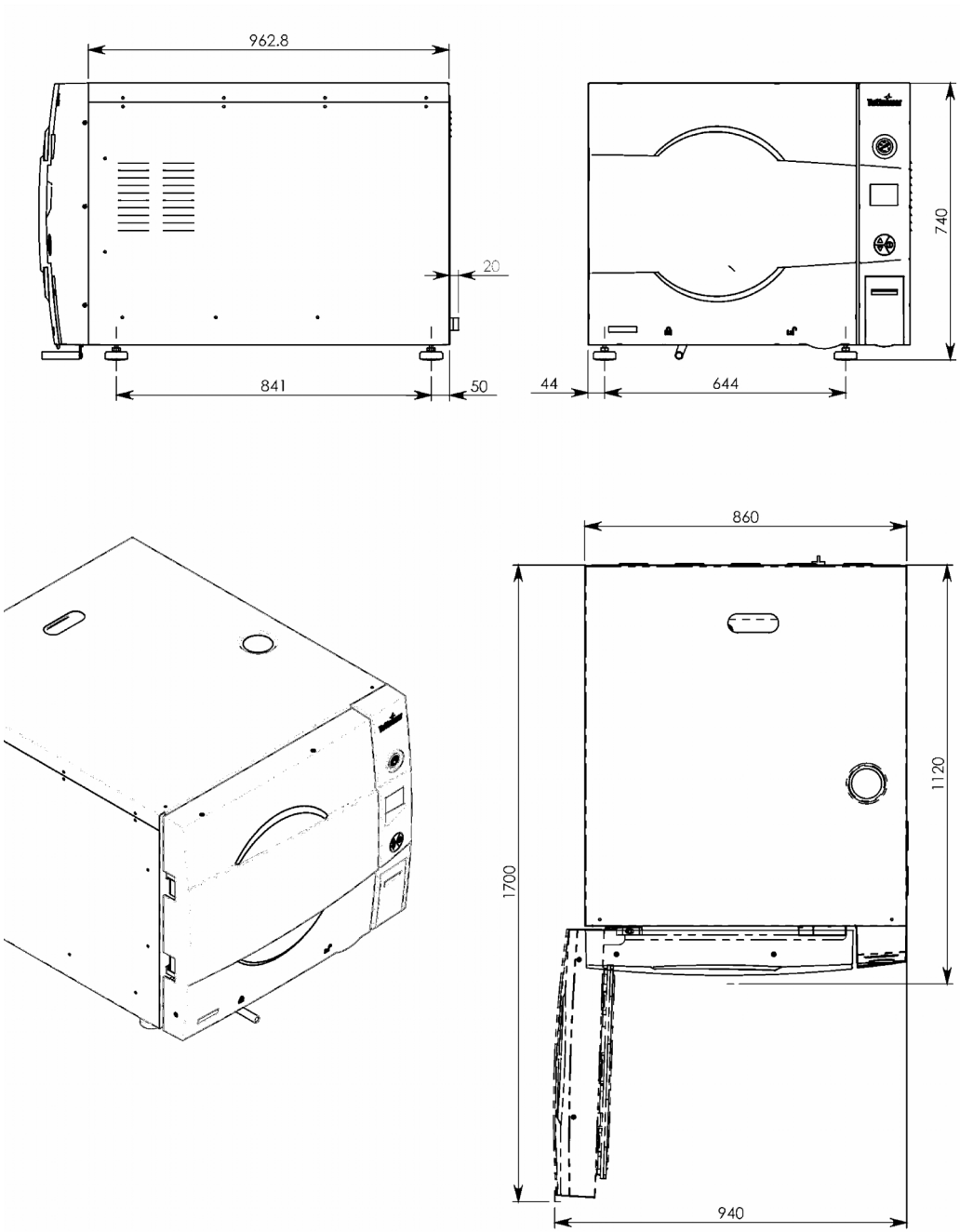

### 3.13 Specifications

Property		Model	
		5050	5075
Overall dimensions	Height	740mm	740mm
	Width	860mm	860mm
	Length	890mm	1120mm
Maximum dimensions (door open)	Width	940mm	940mm
	Height	740mm	740mm
	Length	1460mm	1700mm
Distance between supporting legs	Width	644	644
	Length	611	841
Net weight (kg)		203kg	203kg
Shipping volume (m <sup>3</sup> )		1.67 m <sup>3</sup>	1.67 m <sup>3</sup>
Shipping weight (kg)		290 kg	290 kg
Shipping dimensions	length	1300cm	1300cm
	width	1150cm	1150cm
	height	1120cm	1120cm
Max. Allowable Working pressure (MAWP)		2.8 bar	2.8 bar
Chamber	diameter	500mm	500mm
	Depth	500mm	750mm
Chamber Volume		110 lit.	160 lit.

**3.14 Symbol Description**



**Caution! Consult accompanying documents**



**Caution! Hot surface.**



**Caution! Hot steam.**



**Protective earth (Ground)**

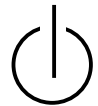

**On-Off**

**FRONT VIEW**

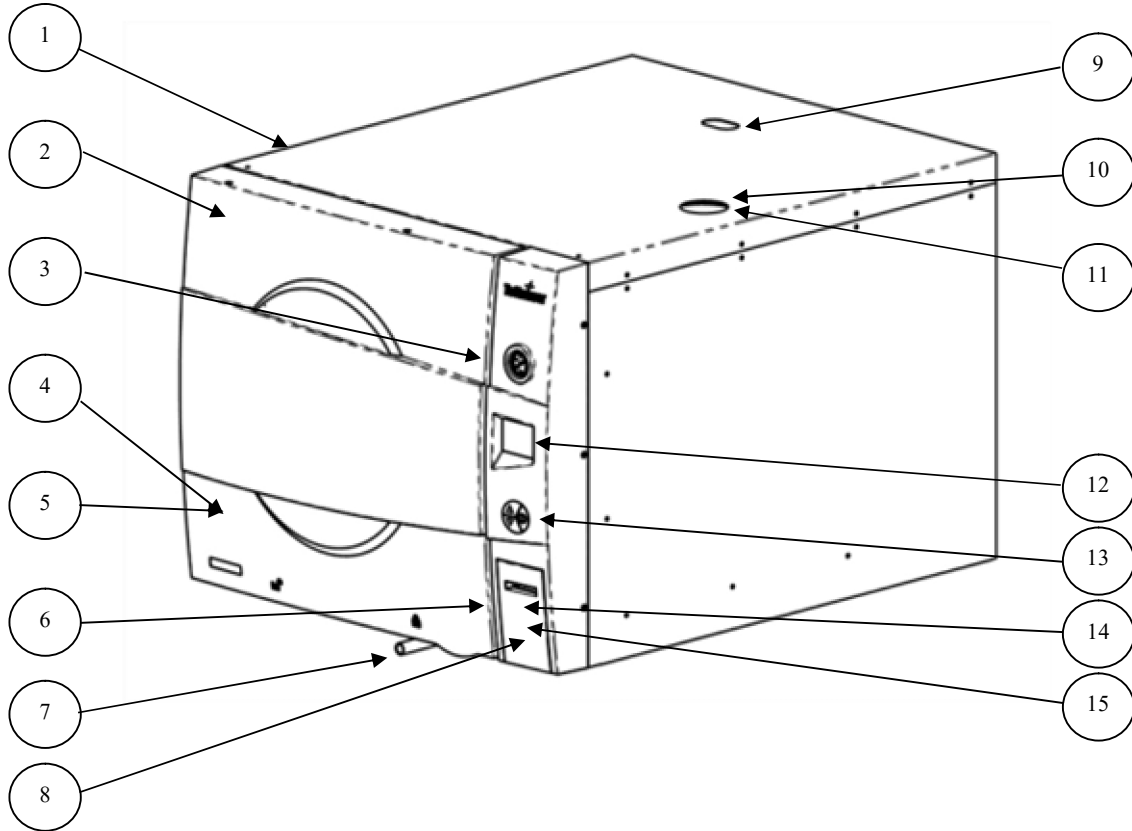

No.	Description		
1	Autoclave cover	9	Safety valve
2	Validation port (under door cover)	10	Water reservoir cover
3	Pressure gauge	11	Water reservoir – assembly
4	Reservoir water drain valve (under door cover)	12	Control panel display
5	Ring for drain valve (under door cover)	13	Control panel keyboard
6	Printer Cover	14	RJ45 Ethernet port
7	Door Closing Handle (MD models)	15	USB port
8	Main switch (under the printer cover)		



**REAR VIEW**

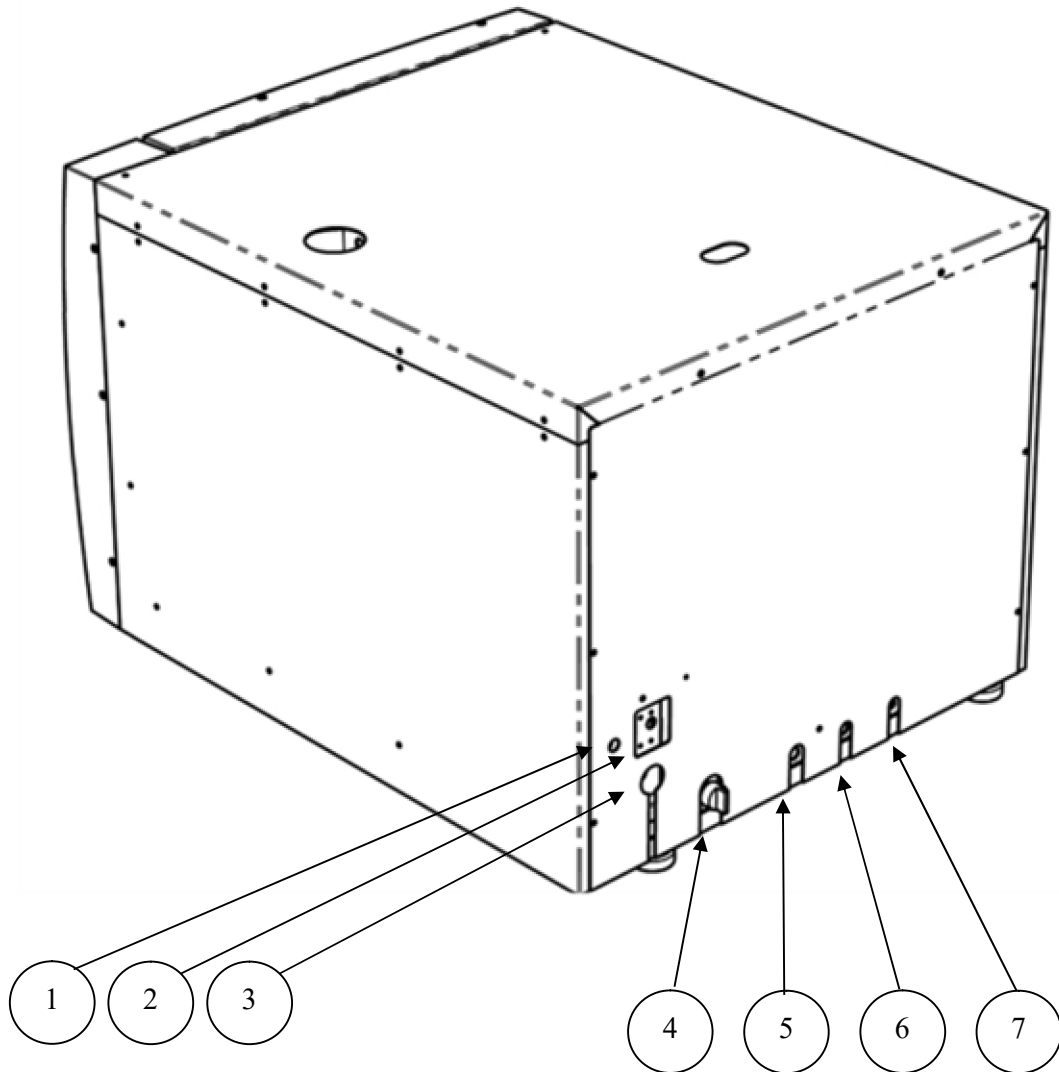

No.	Description
1	Cut off
2	Circuit breaker
3	Electricity
4	Strainer
5	Drain
6	Tap Water
7	Air Inlet

## 4 CONTROL PANEL

### 4.1 CONTROL PANEL DRAWING

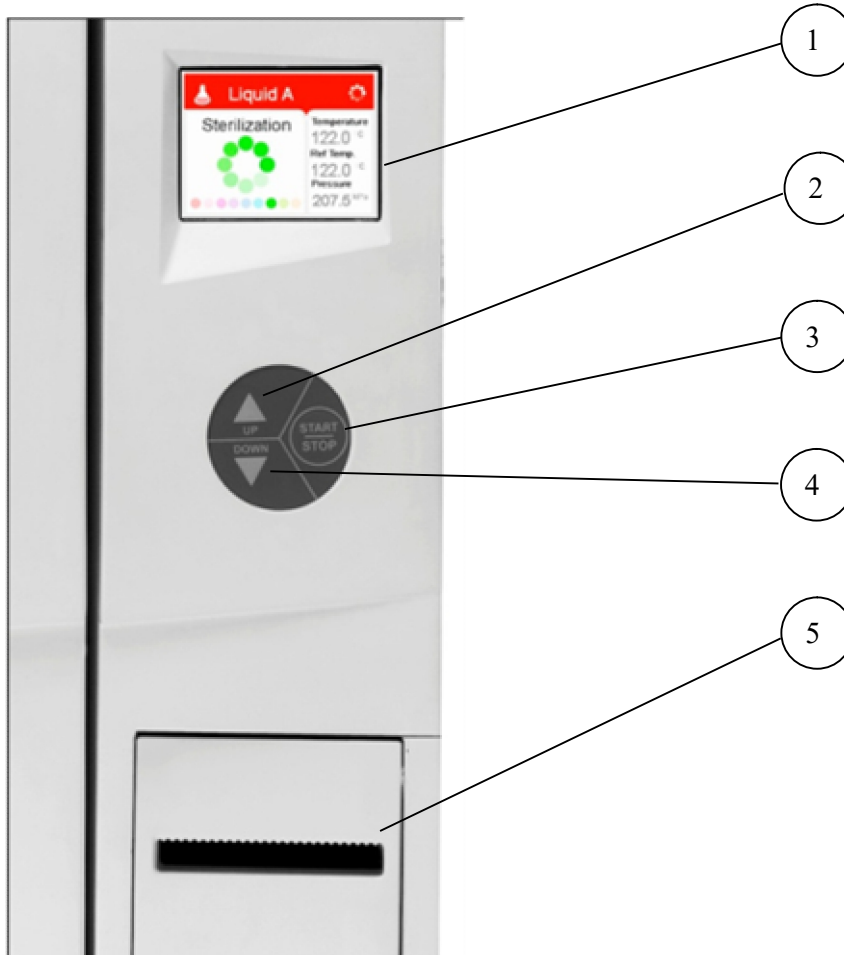

No.	Description
1	Display
2	Keypad: Up Button
3	Keypad: Start/Stop Button
4	Keypad: Down Button
5	Printer

#### 4.2 Description and Functions of the Front Panel Keyboard

The front panel is composed of 3 sections:

1. Display screen.
2. Keypad.
3. Printer

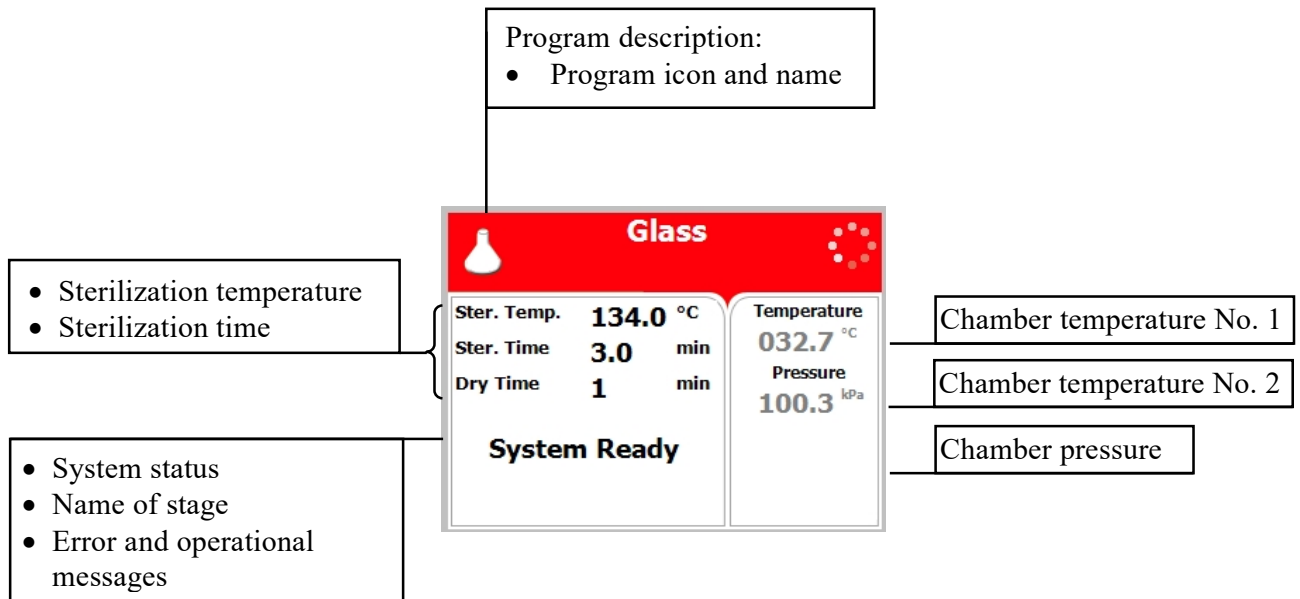

##### Display screen

The display is a LCD panel used to display the current status of the autoclave while using Operational Messages and Error Messages.



## Keypad

The keypad consists of three keys as described below:

<p><b>UP key</b> This key has the following functions:</p> <ul style="list-style-type: none"> <li>• In the menu directories: <ul style="list-style-type: none"> <li>○ This key enables the operator to browse through the cycles.</li> </ul> </li> <li>• In the directories available: <ul style="list-style-type: none"> <li>○ When the cursor is blinking on a number, the <b>UP ▲</b> key increases its value.</li> <li>○ When the cursor is blinking on a menu selection, the <b>UP ▲</b> key allows browsing backward through the menu.</li> <li>○ When adjusting a parameter and the cursor is blinking on “SET” or “EXIT” the <b>UP ▲</b> key activates that procedure.”</li> </ul> </li> </ul>	
<p><b>DOWN key</b> This key has the following functions:</p> <ul style="list-style-type: none"> <li>• In the menu directories: <ul style="list-style-type: none"> <li>○ This key enables the operator to browse through the cycles.</li> </ul> </li> <li>• In the directories available: <ul style="list-style-type: none"> <li>○ When the cursor is blinking on a number, the <b>DOWN ▼</b> key decreases its value.</li> <li>○ When the cursor is blinking on menu selection, the <b>DOWN ▼</b> key allows browsing forward through the menu.</li> <li>○ When adjusting a parameter and the cursor is blinking on “SET” or “EXIT” the <b>DOWN ▼</b> key activates that procedure.</li> </ul> </li> </ul>	
<p><b>START/STOP key</b> This key has the following functions:</p> <ul style="list-style-type: none"> <li>• In the main screen: <ul style="list-style-type: none"> <li>○ Starts the process when the required program was chosen.</li> <li>○ Stops the current process.</li> <li>○ Cancels the ERROR message displayed on the screen and opens the electric door lock.</li> </ul> </li> <li>• In the menu directories: <ul style="list-style-type: none"> <li>○ When the cursor is blinking on a number, the <b>START/STOP ⓘ</b> key enables moving to the next position.</li> <li>○ When the cursor is blinking on a menu selection, the <b>START/STOP ⓘ</b> key activates that selection.</li> </ul> </li> </ul>	

**Printer**



The printer is an optional device. It prints the detailed history of each cycle performed by the autoclave. The printing is on thermal paper with 24 characters per line and records the sterilization cycle information for subsequent consideration.

**4.3 Displayed Error Messages / Symbols**

- The failures are divided into two categories.
- a. Failure that occur before completing the sterilization stage, which in this case will leave the load unsterilized
  - b. Failure that occur after completing the sterilization stage, which in this case will leave the load sterilized

For the list of *Displayed Error Messages / Symbols* see sec. 12. TROUBLESHOOTING









**4.4 Displayed operational messages / Symbols**







Message / Symbol Name	Message / Symbol Description	Required Action
	This symbol is displayed when the door is open.	Close the door.
Door is open (during stand by)	This message is displayed when the door is opened: In standby - if <b>START/STOP</b> is preset.	Close the door to perform a new cycle.
Cycle Ended	This message is displayed when the cycle ended successfully.	Press <b>START/STOP</b> in order to perform a new cycle.
Test Ended	This message is displayed when the test ended.	Press <b>START/STOP</b> in order to perform a new test
	This symbol is displayed when Cycle by Clock mode is performed.	Enter the Admin menu as described in this manual to change the time or to cancel this option.
Cycle by clock	This message is displayed if the user presses <b>START/STOP</b> key while the "cycle by clock" mode is active.	Enter the Admin menu as described in this manual to change the time or to cancel this option.

<p>Atmospheric pressure not set</p>	<p>This message is displayed in order to set the atmospheric pressure by opening the door for 5 minutes.</p>	<p>Open the door for 5 minutes in order to set the Atmospheric pressure.</p>
<p>Critical settings have been updated, Please restart machine in order for changes to be updated</p>	<p>If a change of the autoclave setting was made, a restart operation is required.</p>	<p>Restart the autoclave in order for changes to be updated.</p>
	<p>This message is displayed if the electrode in the chamber senses water.</p>	<p>Perform a new cycle to drain the chamber.</p>

## 5 Sterilization Programs

•

Sterilization Programs			Temp.	Sterilization Time (minutes)	Drying Time (minutes)	C models only	PV models only	BH models only
Icon	Program	Description						
	1.	<b>Glass</b>	134°C (273°F)	3	1			
	2.	<b>Plastic</b>	121°C (250°F)	15	1			
	3.	<b>Liquid A</b>	121°C (250°F)	15				
	4.	<b>Liquid B – Waste*</b>	121°C (250°F)	30				
	5.	<b>Liquid A – Cooling*</b>	121°C (250°F)	15		√		
	6.	<b>Liquid B Waste Cooling*</b>	121°C (250°F)	30		√		
	7.	<b>Bio Hazard 1*</b>	134°C (273°F)	30	1			√
	8.	<b>Bio Hazard 2*</b>	121 (250°F)	45	1			√

Sterilization Programs			Temp.	Sterilization Time (minutes)	Drying Time (minutes)	C models only	PV models only	BH models only
Icon	Program	Description						
	9.	<b>Bio Hazard Liquids*</b>	121 (250°F)	45				√
	10.	<b>Vacuum test (PV only)*</b>		5 +10			√	
	11.	<b>Warm-Up*</b>	80 °C (176°F)	20				
	12.	<b>Isothermal*</b>	80 °C (176°F)	20				
	13.	<b>Air Mixture*</b>	121°C (250°F)	15				
	14.	<b>Glass Test*</b>	121°C (250°F)	20				
	15.	<b>Durham*</b>	121°C (250°F)	15				

**\*These programs are optional**



During the process, the stages of the cycle will be displayed on the screen:

The stages names are as follows:

- Start
- Pulse Low (PV models only)
- Pulse High (PV models only)
- Water Inlet
- Heating
- Sterilization
- Cooling (C models only)
- Exhaust
- Drying (PV model only)
- Ending

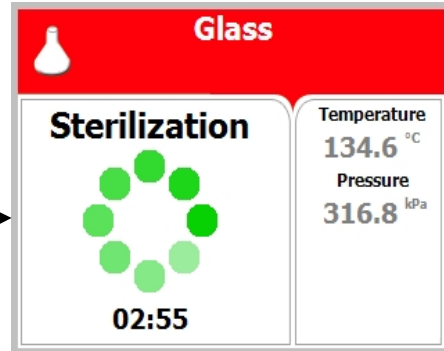

## 5.1 Program 1: Glass

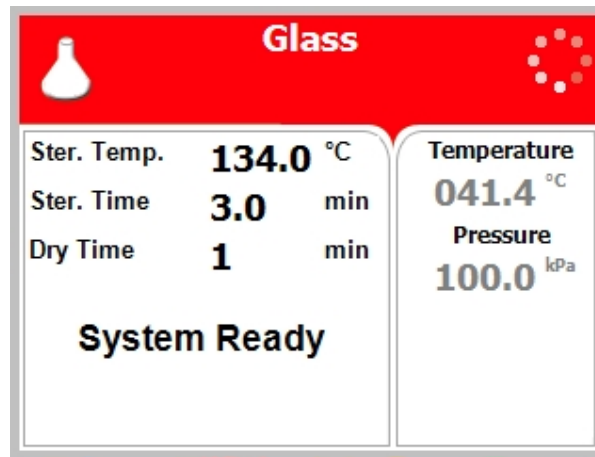

For glass instruments, when the manufacturer recommends autoclaving at temperatures of 134°C (273°F). Drying stage is available for PV (pre-vacuum) models only.

### ***Nominal parameters default settings***

- Sterilization temperature: 134°C (273°F).
- Sterilization time: 3 minutes.
- Drying time: 1 minute. (PV – pre-vacuum models only).

### ***Operations sequence:***

- (PV, pre-vacuum models only) **Pulse low/Pulse high:** at one pulse it will build vacuum down to 25 kPa.
- **Water Inlet:** Water enters the chamber
- **Heating:** The chamber and is heated by actuation of electrical heaters until the sterilization temperature is reached.
- **Sterilization:** Sterilization temperature is maintained constant during the sterilization time.
- **Cooling:** N/A.
- **Fast Exhaust:** the steam is exhausted out of the chamber at a fast rate until pressure decreases to ambient pressure.
- (PV, pre-vacuum model only) **Drying:** vacuum is built up and the air pump is working.
- **Ending:** The system checks that End temperature and End pressure have been reached, and then releases the door.

## 5.2 Program 2: Plastic

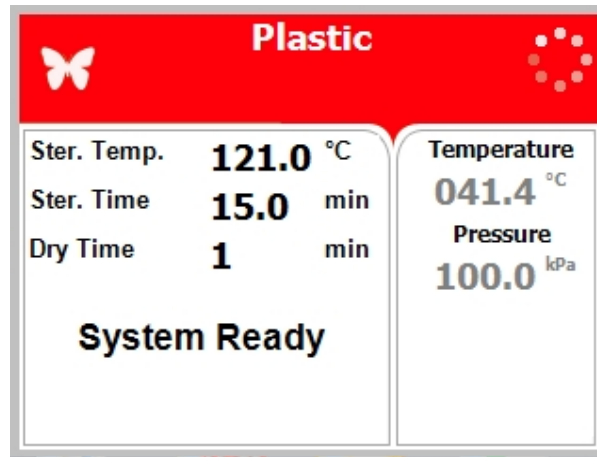

For plastic and other delicate instruments, when the manufacturer recommends autoclaving at temperatures of 121°C (250°F). Drying stage is available for PV (pre-vacuum) models only.

### ***Nominal parameters default settings***

- Sterilization temperature: 121°C (250°F)
- Sterilization time: 15 minutes
- Drying time: 1 minute (PV – pre-vacuum models only).

### ***Operations sequence:***

- (PV, pre-vacuum models only) **Pulse low/Pulse high:** at one pulse it will build vacuum down to 25 kPa.
- **Water Inlet:** Water enters the chamber
- **Heating:** The chamber is heated by actuation of electrical heaters until the sterilization temperature is reached.
- **Sterilization:** Sterilization temperature is maintained constant during the sterilization time.
- **Cooling:** N/A
- **Fast Exhaust:** the steam is exhausted out of the chamber at a fast rate until pressure decreases to ambient pressure.
- (PV, pre-vacuum models only) **Drying:** vacuum is built up and the air pump is working.
- **Ending:** The system checks that End temperature and End pressure have been reached, and then releases the door.

### 5.3 Program 3: Liquid A

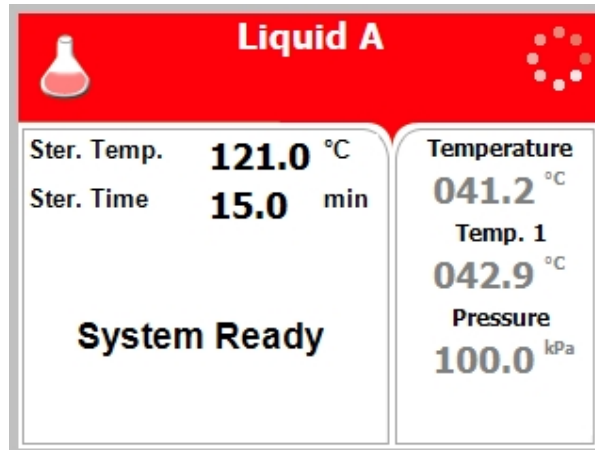

For liquids when the manufacturer recommends autoclaving at temperatures of 121°C (250°F) for 15 minutes.



#### **Cautions!**

**Both PT100 temperature sensors must be inside the bottles. For proper sterilization, fill the bottles with approximately the same amount of liquid.**

#### ***Nominal parameters default settings***

- Sterilization temperature: 121°C (250°F)
- Sterilization time: 15 minutes

#### ***Operations Sequence***

- (PV, pre-vacuum models only) **Pulse low/Pulse high:** at one pulse it will build vacuum down to 25 kPa.
- **Water Inlet:** Water enters the chamber
- **Heating:** The chamber is heated by actuation of electrical heaters until the sterilization temperature is reached.
- **Sterilization:** Sterilization temperature is maintained constant during the sterilization time.
- **Cooling:** N/A
- **Slow Exhaust:** Steam is exhausted from the chamber at a slow rate, until it reaches the pressure of 30 kPa above the ambient pressure. Then steam is exhausted out of the chamber at a fast rate until pressure decreases to ambient pressure.
- **Drying:** N/A
- **Ending:** The system checks that End temperature and End pressure have been reached, and then releases the door.

#### 5.4 Program 4: Liquid B – Waste

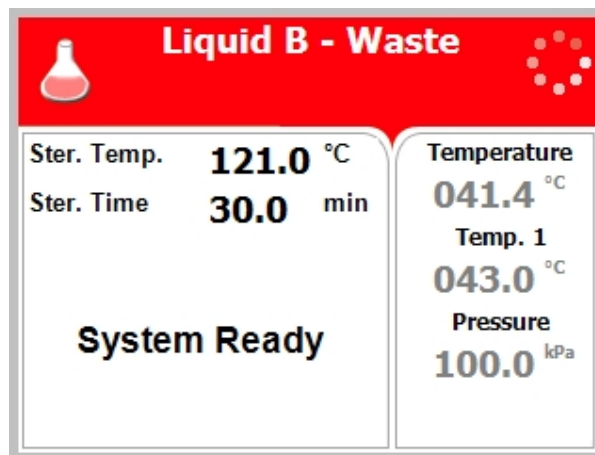

For liquids when the manufacturer recommends autoclaving at temperatures of 121°C (250°F) for 30 minutes, such as liquid waste.



#### Cautions!

**Both PT100 temperature sensors must be inside the bottles.**  
For proper sterilization, fill the bottles with approximately the same amount of liquid.

#### Nominal parameters default settings

- Sterilization temperature: 121°C (250°F)
- Sterilization time: 30 minutes

#### Operations Sequence

- (PV, pre-vacuum models only) **Pulse low/Pulse high:** at one pulse it will build vacuum down to 25 kPa.
- **Water Inlet:** Water enters the chamber
- **Heating:** The chamber is heated by actuation of electrical heaters until the sterilization temperature is reached.
- **Sterilization:** Sterilization temperature is maintained constant during the sterilization time.
- **Cooling:** N/A
- **Slow Exhaust:** Steam is exhausted from the chamber at a slow rate, until it reaches the pressure of 30 kPa above the ambient pressure. Then steam is exhausted out of the chamber at a fast rate until pressure decreases to ambient pressure.
- **Drying:** N/A
- **Ending:** The system checks that End temperature and End pressure have been reached, and then releases the door.

### 5.5 Program 5: Liquid A – Cooling (C – cooling models only)

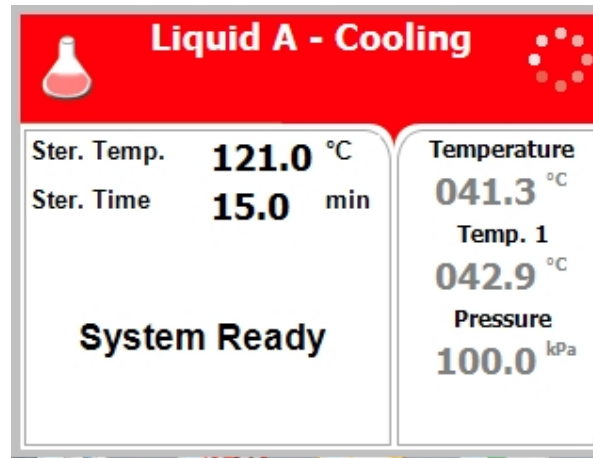

For liquids when the manufacturer recommends autoclaving at temperatures of 121°C (250°F). for 15 minutes.



#### **Cautions!**

**Both PT100 temperature sensors must be inside the bottles. For proper sterilization, fill the bottles with approximately the same amount of liquid.**

#### **Nominal parameters default settings**

- Sterilization temperature: 121°C (250°F).
- Sterilization time: 15 minutes.

#### **Operations sequence:**

- (PV, pre-vacuum models only) **Pulse low/Pulse high:** at one pulse it will build vacuum down to 25 kPa.
- **Water Inlet:** Water enters the chamber
- **Heating:** The chamber is heated by actuation of electrical heaters until the sterilization temperature is reached.
- **Sterilization:** Sterilization temperature is maintained constant during the sterilization time.
- **Cooling:** Forced cooling to the required end temperature, chamber pressure remains at approx. 300 kPa and the cooling valve is opened.
- **Fast Exhaust:** the steam is exhausted out of the chamber at a fast rate until pressure decreases to ambient pressure.
- **Drying:** N/A

- **Ending:** The system checks that End temperature and End pressure have been reached, and then releases the door.

**5.6 Program 6: Liquid B – Waste Cooling (C – cooling models only)**

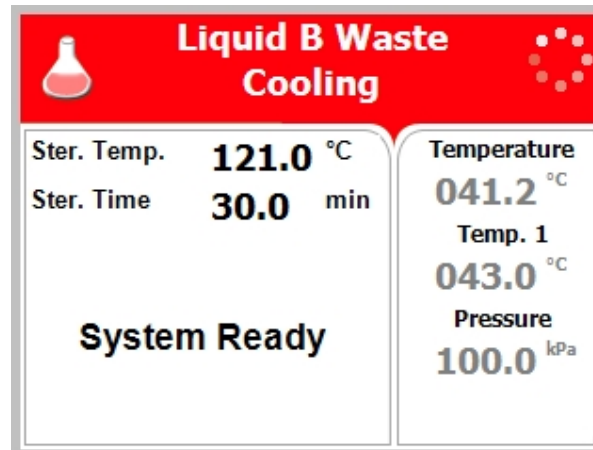

For liquids when the manufacturer recommends autoclaving at temperatures of 121°C (250°F) for 30 minutes, such as liquid waste.



**Cautions!**

**Both PT100 temperature sensors must be inside the bottles. For proper sterilization, fill the bottles with approximately the same amount of liquid.**

**Nominal parameters default settings**

- Sterilization temperature: 121°C (150°F).
- Sterilization time: 30 minutes.

**Operations sequence:**

- (PV, pre-vacuum models only) **Pulse low/Pulse high:** at one pulse it will build vacuum down to 25 kPa.
- **Water Inlet:** Water enters the chamber
- **Heating:** The chamber is heated by actuation of electrical heaters until the sterilization temperature is reached.
- **Sterilization:** Sterilization temperature is maintained constant during the sterilization time.
- **Cooling:** Forced cooling to the required end temperature, chamber pressure remains at approx. 300 kPa and the cooling valve is opened.
- **Fast Exhaust:** the steam is exhausted out of the chamber at a fast rate until pressure decreases to ambient pressure.

- **Drying:** N/A
- **Ending:** The system checks that End temperature and End pressure have been reached, and then releases the door.

### 5.7 Program 7: Bio Hazard 1 (BH, bio-hazard models only)

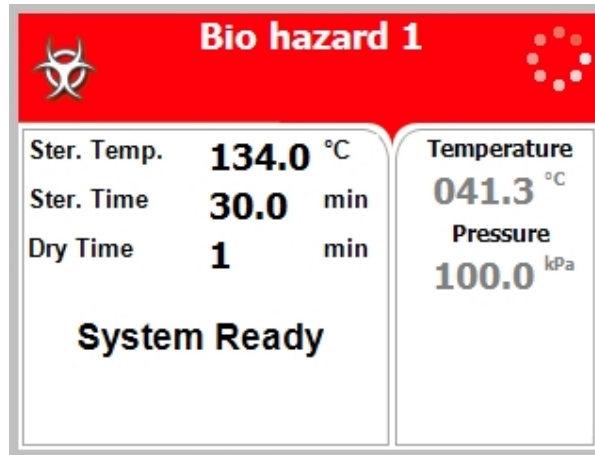

**All exhaust from the chamber before completion of the Sterilization stage is performed through the bio-hazard filter.** For instruments, when the manufacturer recommends autoclaving at temperatures of 134°C (273°F) for 30 minutes. Drying stage is available for PV (pre-vacuum) models only.

#### **Nominal parameters default settings**

- Sterilization temperature: 134°C (273°F)
- Sterilization time: 30 minutes
- Drying time: 1 minute. (PV – pre-vacuum models only).
- 

#### **Operations sequence:**

- (PV, pre-vacuum models only) **Pulse low/Pulse high:** at one pulse it will build vacuum down to 25 kPa. **All exhaust from the chamber is performed through the bio-hazard filter.**
- **Water Inlet:** Water enters the chamber
- **Heating:** The chamber is heated by actuation of electrical heaters until the sterilization temperature is reached.
- **Sterilization:** Sterilization temperature is maintained constant during the sterilization time.
- **Cooling:** N/A
- **Fast Exhaust:** the steam is exhausted out of the chamber at a fast rate until pressure decreases to ambient pressure.  
**Note:** If the cycle fails, fast exhaust is performed through the bio-hazard filter. Some water may remain in the chamber after a failed



cycle. To remove such water, press Start and repeat the cycle. If the problem persists, call for service.

- (PV, pre-vacuum models only) **Drying:** vacuum is built up and the air pump is working.
- **Ending:** The system checks that End temperature and End pressure have been reached, and then releases the door.

### 5.8 Program 8: Bio Hazard 2 (BH, bio-hazard models only)

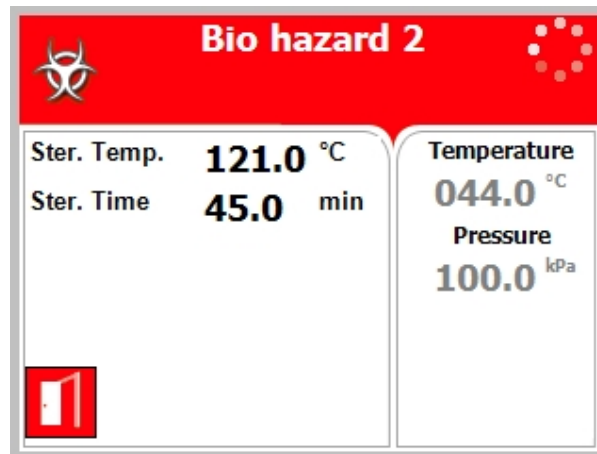

**All exhaust from the chamber before completion of the Sterilization stage is performed through the bio-hazard filter.** For instruments, when the manufacturer recommends autoclaving at temperatures of 121°C (250°F) for 45 minutes. Drying stage is available for PV (pre-vacuum) models only.

#### **Nominal parameters default settings**

- Sterilization temperature: 121°C (250°F)
- Sterilization time: 45 minutes
- Drying time: 1 minute. (PV – pre-vacuum models only).

#### **Operations sequence:**

- (PV, pre-vacuum models only) **Pulse low/Pulse high:** at one pulse it will build vacuum down to 25 kPa. **All exhaust from the chamber is performed through the bio-hazard filter.**
- **Water Inlet:** Water enters the chamber
- **Heating:** The chamber is heated by actuation of electrical heaters until the sterilization temperature is reached.
- **Sterilization:** Sterilization temperature is maintained constant during the sterilization time.
- **Cooling:** N/A

- **Fast Exhaust:** the steam is exhausted out of the chamber at a fast rate until pressure decreases to ambient pressure.
- **Note:** If the cycle fails, fast exhaust is performed through the bio-hazard filter. Some water may remain in the chamber after a failed cycle. To remove such water, press Start and repeat the cycle. If the problem persists, call for service.
- (PV, pre-vacuum models only) **Drying:** vacuum is built up and the air pump is working.
- **Ending:** The system checks that End temperature and End pressure have been reached, and then releases the door.

### 5.9 Program 9: Bio Hazard Liquids (BH, bio-hazard models only)

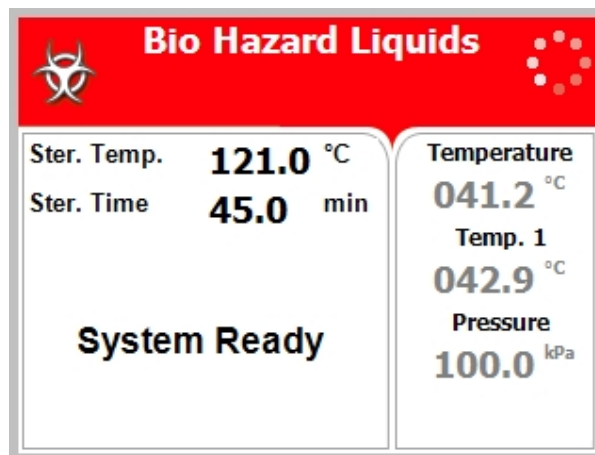

All exhaust from the chamber before completion of the Sterilization stage is performed through the bio-hazard filter. For liquids when the manufacturer recommends autoclaving at temperatures of 121°C (250°F) for 45 minutes.



#### Cautions!

Both PT100 temperature sensors must be inside the bottles. For proper sterilization, fill the bottles with approximately the same amount of liquid.

#### Nominal parameters default settings

- Sterilization temperature: 121°C (250°F)
- Sterilization time: 45 minutes

#### Operations sequence:

- (PV, pre-vacuum models only) **Pulse low/Pulse high:** at one pulse it will build vacuum down to 25 kPa. All exhaust from the chamber is performed through the bio-hazard filter.

- **Water Inlet:** Water enters the chamber
- **Heating:** The chamber is heated by actuation of electrical heaters until the sterilization temperature is reached.
- **Sterilization:** Sterilization temperature is maintained constant during the sterilization time.
- **Cooling:** N/A
- **Slow Exhaust:** Steam is exhausted from the chamber at a slow rate, until it reaches the pressure of 30 kPa above the ambient pressure. Then steam is exhausted out of the chamber at a fast rate until pressure decreases to ambient pressure.  
**Note:** If the cycle fails, fast exhaust is performed through the bio-hazard filter. Some water may remain in the chamber after a failed cycle. To remove such water, press Start and repeat the cycle. If the problem persists, call for service.
- **Drying:** N/A
- **Ending:** The system checks that End temperature and End pressure have been reached, and then releases the door.

#### 5.10 Program 10: Vacuum Test (PV, pre-vacuum models only)

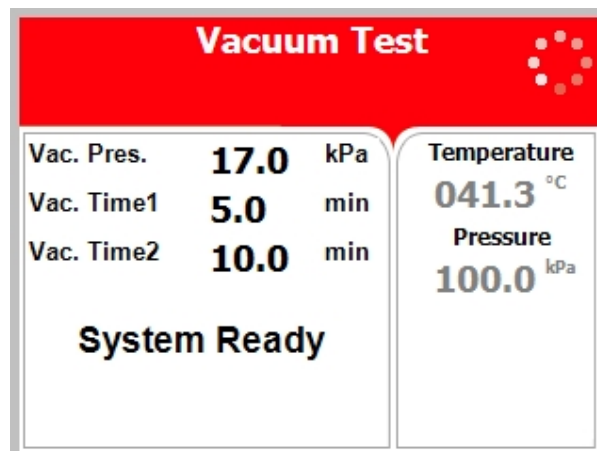

Vacuum Test is a test program with the following parameters:

#### ***Nominal parameters default settings***

- Vacuum pressure: 17.0 kPa
- Vacuum time 1: 5 minutes
- Vacuum time 2: 10 minutes

#### ***Operations sequence:***

- Vacuum is produced in the chamber down to P1=17 kPa. At this stage all the valves close. The autoclave remains in this stage for 5

minutes. This period enables the condition in the chamber to reach equilibrium.

- After the 5 minutes have elapsed, the printer records the pressure that is referred to as P2. At this point the test begins and lasts 10 minutes.
- At the end of the test, the printer records the results. The pressure at the end of the test is referred to as P3. The rate of change of P3-P2 shall not exceed 0.13 kPa/min.).

### 5.11 Program 11: Warm-Up

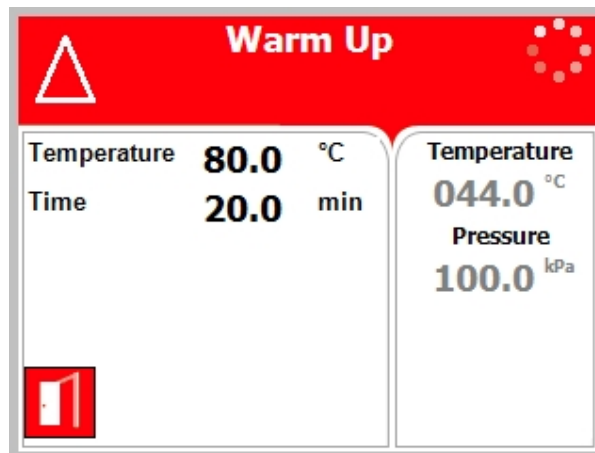

Pre-warming the chamber at 80°C (176°F) without drying.



**Caution!**

**This is not a sterilization program!**

#### ***Nominal parameters default settings***

- Warm-up temperature: 80°C (176°F).
- Warm-up time: 20 minutes.

#### ***Operations sequence:***

- **Pulse low/Pulse high:** N/A
- **Heating:** Water enters the chamber and is heated by actuation of electrical heaters until the warm-up temperature is reached.
- **Warm up:** Warm up temperature is maintained constant for the warm-up time.
- **Sterilization:** N/A.
- **Cooling:** N/A.
- **Fast Exhaust:** the steam is exhausted out of the chamber at a fast rate until pressure decreases to ambient pressure.

- **Drying:** N/A.  
**Note:** Some water may remain in the chamber.

### 5.12 Program 12: Isothermal

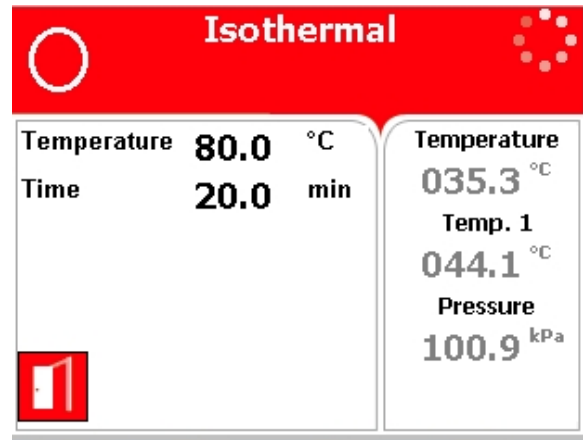

For liquids when the manufacturer recommends autoclaving at 60-100°C (140-212°F) with no drying. Recommending for melting of agar, pasteurization etc.



**Caution!**

**This is not a sterilization program!**

Put one PT100 inside the bottle, leave the second one hanging in the chamber outside the bottle (see below).



#### ***Nominal parameters default settings***

- Heating temperature (default): 80°C (176°F).
- Heating time: 20 minutes.

#### ***Operations sequence:***

- **Water Inlet:** Water enters the chamber

- **Heating:** The chamber is warmed up until the Keep-Heat temperature is reached inside the chamber.
- **Keep Heat:** Keep-Heat temperature is maintained constant for the preset Keep-Heat time.
- **Cooling:** N/A.
- **Fast Exhaust:** the steam is exhausted out of the chamber at a fast rate until pressure decreases to ambient pressure.
- **Drying:** N/A
- **Ending:** The system checks that End temperature and End pressure have been reached, and then releases the door.

**Note:** Some water may remain in the chamber.

### 5.13 Program 13: Air Mixture

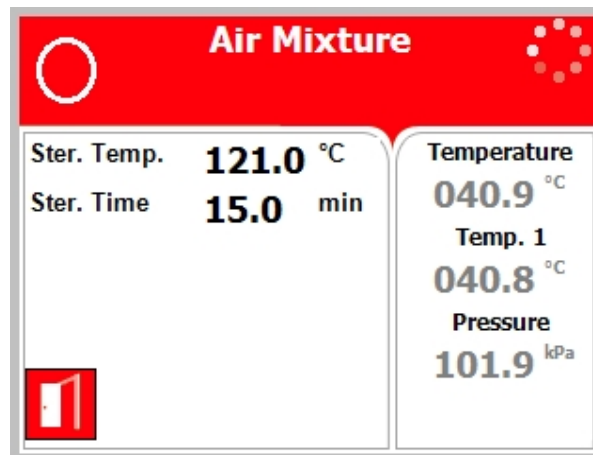

This program is intended for liquids in soft packages when the manufacturer recommends autoclaving at temperature of 121°C (250°F) for 15 minutes.

Sterilization is controlled in a way that the sterilization pressure remains approx. 30% above the theoretical pressure corresponding to the same temperature according to the steam table. These intends for prevent swelling or warping of the package.



#### **Cautions!**

**Both PT100 temperature sensors must be inside the bottles. For proper sterilization, fill the bottles with approximately the same amount of liquid.**

#### ***Nominal parameters default settings***

- Sterilization temperature: 121°C (250°F).
- Sterilization time: 15 minutes.

**Operations sequence:**

- **Heating:** Air enters the chamber followed by steam that heats it up until the sterilization temperature is reached. Air adds pressure needed to prevent swelling or warping of soft plastic items. Chamber fan is used to mix air with steam.
- **Sterilization:** Sterilization is controlled in a way that the sterilization pressure remains approx. 30% above the theoretical pressure corresponding to the same temperature according to the steam table.
- **Cooling:** Forced cooling to the required end temperature, chamber pressure remains at approx. 300 kPa and the cooling valve is opened.
- **Fast Exhaust:** The steam is exhausted out of the chamber at a fast rate until pressure decreases to ambient pressure.
- **Drying:** N/A
- **Ending:** The system checks that End temperature and End pressure have been reached, and then releases the door.

**5.14 Program 14: Glass Test**

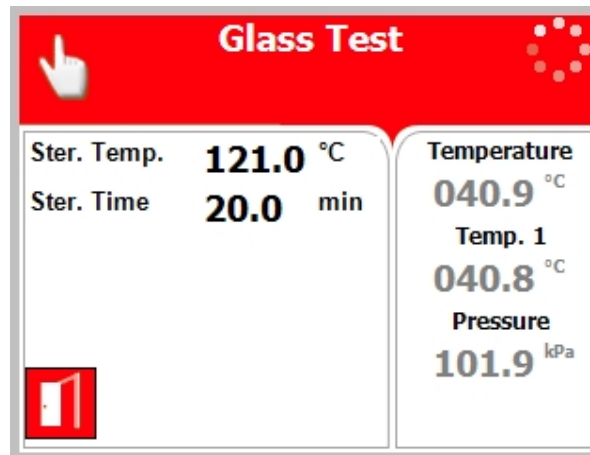

This cycle is intended to check the durability of the bottles for liquids when the manufacturer recommends autoclaving at temperatures of 121°C (250°F) for 20 minutes.



**Cautions!**

**Both PT100 temperature sensors must be inside the bottles. For proper sterilization, fill the bottles with approximately the same amount of liquid.**

**Nominal parameters default settings**

- Sterilization temperature: 121°C (250°F).
- Sterilization time: 20 minutes.

**Operations sequence:**

- **Heating:** Steam enters the chamber and heats it up until the sterilization temperature is reached.  
**During the interval of the heating stage, between 100°C and 121°C, the heating rate is kept to approximately a rise of 1 degree per minute. This will make the last stage of the heating take approximately 21 minutes. This is to check the durability of the bottles.**
- **Sterilization:** Sterilization temperature is maintained constant during the sterilization time.
- **Cooling:** Forced cooling to the required end temperature, chamber pressure remains at approx. 300 kPa and the cooling valve is opened.  
**During the interval of the cooling stage, between 121°C and 100°C the cooling rate is kept to approximately a decrease of 1 degree per minute. This will make the last stage of the cooling take approximately 21 minutes. This is to check the durability of the bottles.**
- **Fast Exhaust:** The steam is exhausted out of the chamber at a fast rate until pressure decreases to ambient pressure.
- **Drying:** N/A
- **Ending:** The system checks that End temperature and End pressure have been reached, and then releases the door.

**5.15 Program 15: Durham**

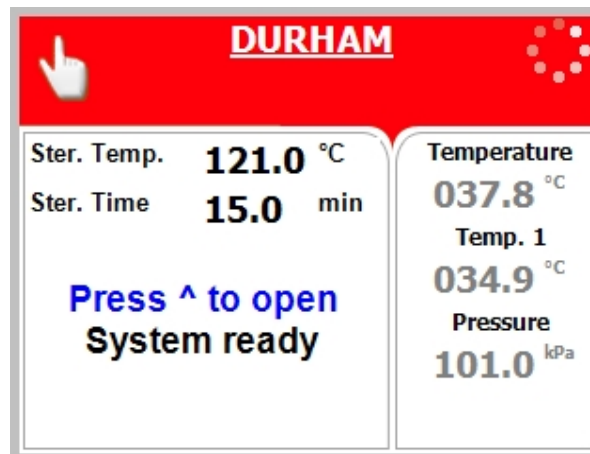

For liquids when the manufacturer recommends autoclaving at temperatures of 121°C (250°F) for 15 minutes.



**Cautions!**

**Both PT100 temperature sensors must be inside the bottles.**



---

**For proper sterilization, fill the bottles with approximately the same amount of liquid.**

***Nominal parameters default settings***

- Sterilization temperature: 121°C (250°F).
- Sterilization time: 15 minutes.

***Operations sequence:***

- **(PV, pre-vacuum models only) Pulse low/Pulse high:** at one pulse it will build vacuum down to 25 kPa.
- **Heating:** Steam enters the chamber and heats it up until the sterilization temperature is reached.
- **Sterilization:** Sterilization temperature is maintained constant during the sterilization time.
- **Slow Exhaust:** Steam is exhausted from the chamber at a slow rate, until chamber temperature reaches 105°C.
- **Cooling:** Forced cooling to the required end temperature, chamber pressure remains at approx. 140kPa, and the cooling valve is opened.
- **Fast Exhaust:** The steam is exhausted out of the chamber at a fast rate until pressure decreases to ambient pressure.
- **Drying:** N/A
- **Ending:** The system checks that End temperature and End pressure have been reached, and then releases the door.

## 6 SCREENS

### 6.1 Screens following a completely successful cycle – "Cycle Ended"

1. System Ready

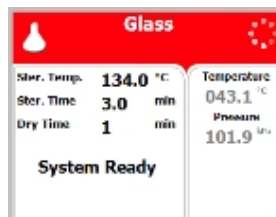

2. Pulse Low (PV model only)

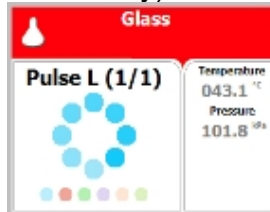

Pulse High (1/1) (PV model only)

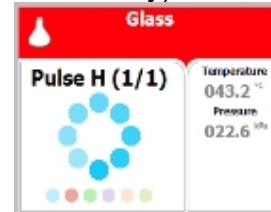

2. Insert Water



3. Heating

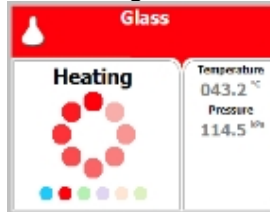

4. Sterilization



5. Exhaust

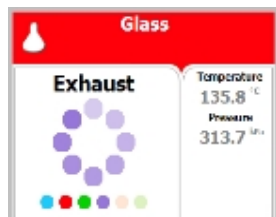

5. Drying (PV model only)

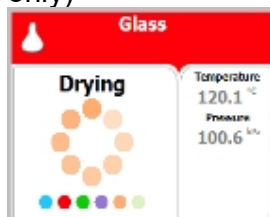

6. Ending

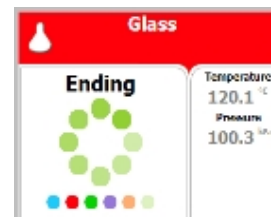

7. Cycle Ended



**6.2 Screens following aborted cycles after complete sterilization stage**

The sterilization phase ended successfully – cycle ended and the reason of failure is displayed  
For example the next two scenarios:

**Canceled by user after complete sterilization stage**

The cycle ended successfully, the reason for aborted cycle is displayed.

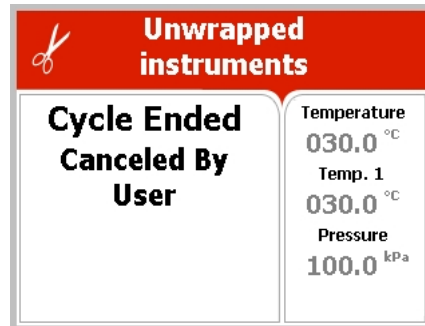

**Pressure Time Error Failure occurrence after complete sterilization stage**

The cycle ended successfully, the reason of failure is displayed.

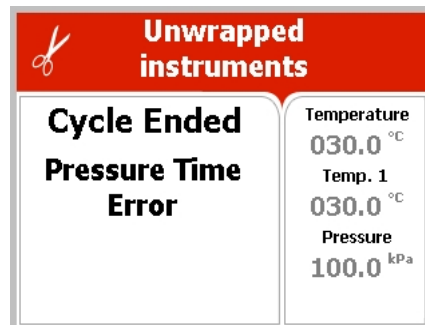

**6.3 Screens following a fail cycle:**

In this case, the display becomes yellow, a warning sign  and the reason of failure will be displayed.  
For example the next two scenarios:

**Failure according to Pressure Time Error**

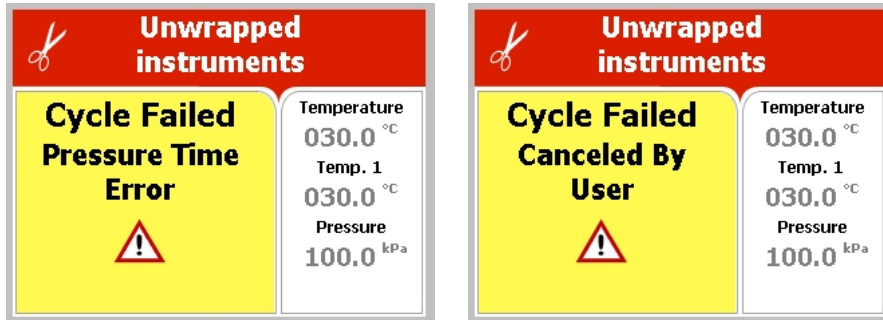

**Failure according to Cancellation by user before complete sterilization stage**

When "Cycle Failed" appears on the screen, the user shall press **START/STOP** key in order to delete the "Cycle Failed" message

An example for all displayed warnings according to Cycle Failed:

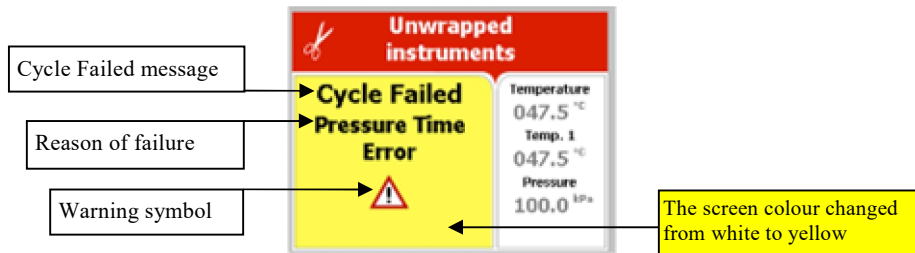

## 7 **Checking and Changing Parameters and other data**

Bacsoft control panel allows changing parameters of the cycle and of the system, exporting various data to, and importing from, a USB device or to the printer, and some other options.

Cycle parameters are changeable for Custom programs only (see Duplicate cycles), with the exception of the Temperature sensors, Displayed inputs, and Dry Time.

### 7.1 **Browsing through the menus**

Now you will learn how to browse through the folders. When you read the Directories and subdirectories chapter with links to specific menus, you will need to know how to browse through the folders using the autoclave control panel. Below is the instruction.

Login as User (see 9.4). The Main menu screen appears. To browse through the menu:

1. Press the Up and Down keys to scroll through the menus.
2. Press the Start/Stop key to enter the next screen (i.e. to get one level down).
3. Repeat steps 1 and 2 to enter the next screen until you get to required screen.

Below are the example screens for the following menu: Cycle Parameters\ Drying\ Dry Time:

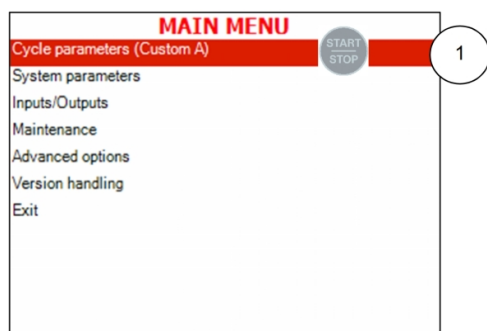

Login as Technician (see 1.4). The Main menu screen appears.  
Press the Start/Stop key to enter the Cycle parameters menu.

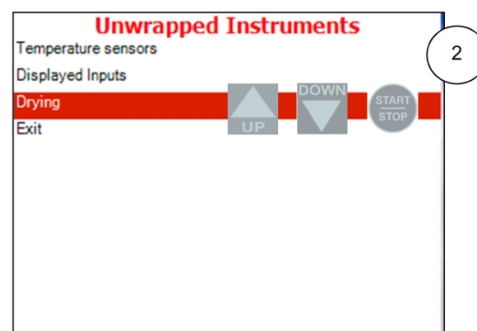

Press the Up and Down keys to scroll through the menus until you get to Drying, then press the Start/Stop key to enter the Drying menu.

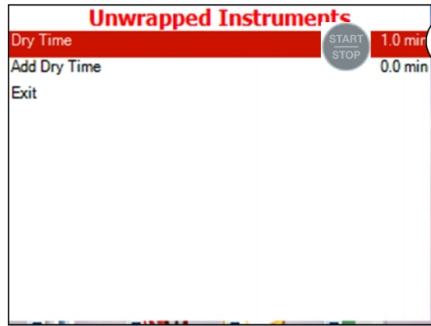

Press the Start/Stop key again to enter the Dry Time menu.

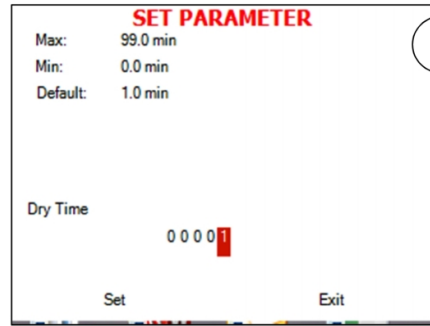

Now you have reached the required screen: Changing the dry time parameter. The path is: **Cycle parameters\Drying\Dry Time.**

**Note:** To exit every screen and to return to the previous screen (to get one level up):

- move the cursor to Exit by pressing the UP or DOWN keys and then press the Start/Stop key.
- or -
- press the UP and DOWN keys simultaneously.

In the next chapter you will see how to change the required parameter as desired.

## 7.2 **Changing a Parameter**

You have browsed through the menus and reached the parameter changing screen as explained above. Now you can change the required parameter as desired. To do so:

1. Enter the required value as follows:
  - Press the Up and Down keys to change the value of the digit.
  - Press the Start/Stop key to move the cursor to the next digit to the left.
2. When finished, press the Start/Stop key repeatedly until you move the cursor to Set.
3. Press the Up or Down key to confirm the new value and to exit the parameter changing screen.

Below is the typical parameter changing screen:

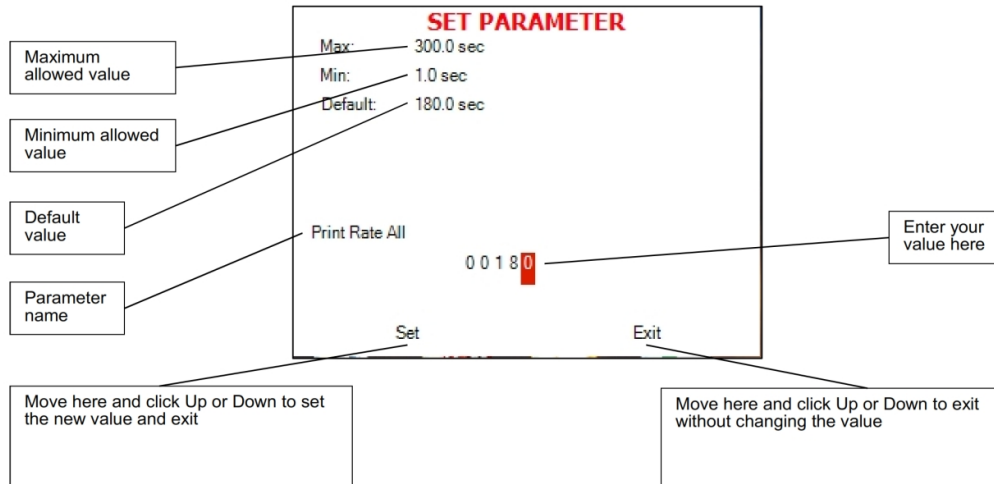

**Note:** Please note the maximum and minimum values for this parameter shown on the screen. Your value must be within these boundaries.

Below is the example of changing the Dry time parameter on the screen used in the previous section:

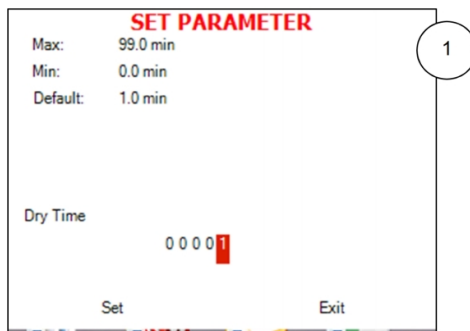

Browse to Changing dry time screen as explained in the previous chapter

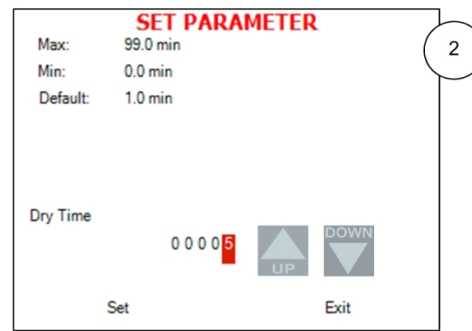

Use Up and Down keys to change the value of the digit

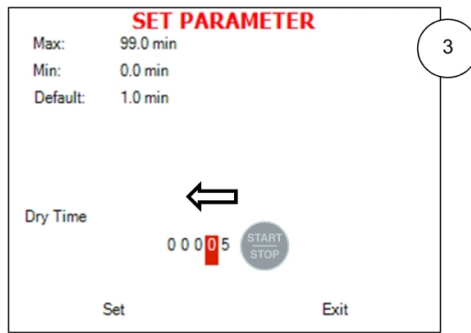

Press the Start/Stop key to move the cursor to the next digit to the left.

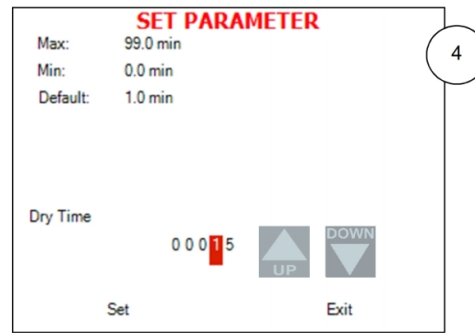

Press the Up and Down keys to change the value of the digit

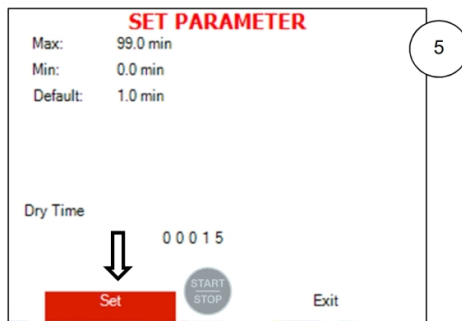

When finished, press the Start/Stop key repeatedly until you move the cursor to Set.

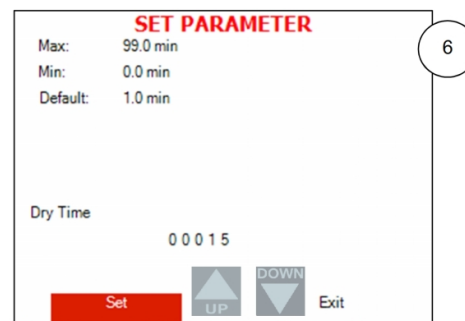

Press the Up or Down key to confirm the new value and to exit the parameter changing screen.

**Note:** To exit every screen and to return to the previous screen:

- move the cursor to Exit by pressing the UP or DOWN keys and then press the Start/Stop key
- or -
- press the UP and DOWN keys simultaneously

### 7.3 Quick options screen

When the autoclave is on and no cycle is running, press Up and Down keys simultaneously to enter the Quick options screen. Most of the options require login, and their availability depends on user authority (user, or technician). Login command is the last line on this screen. Quick options are options available without login.



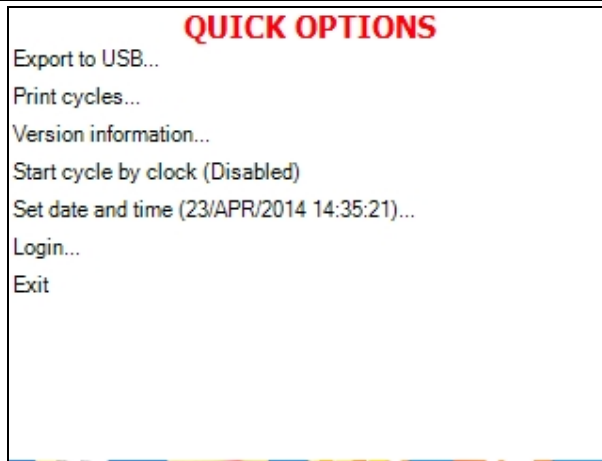

Below you can find instructions how to login and enter the Main menu. Section 9.1 above explains how to browse through the menus; section 9.2 explains how to change a parameter.

Below is the explanation of some Quick Options.

***Version Information***

This directory allows viewing information of the current, factory default, and previous software versions.

1. Enter the Version information screen.

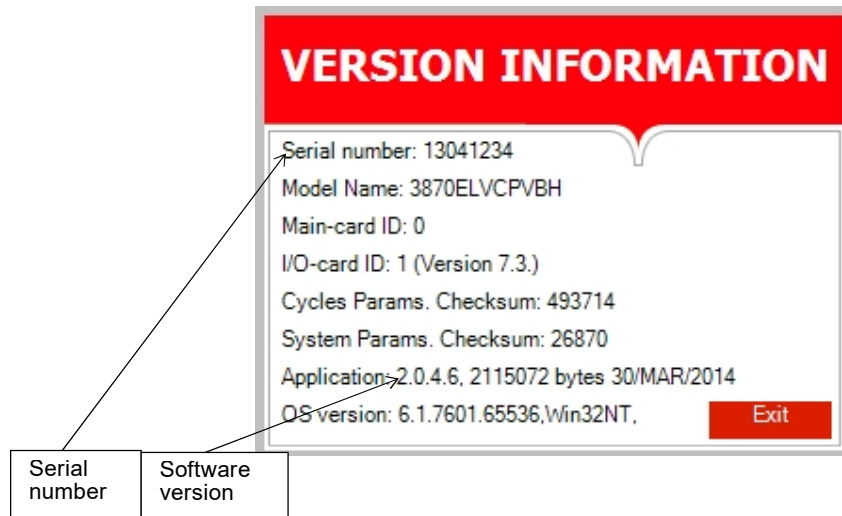

## ***Start cycle by clock***

This subdirectory enables the operator to start the cycle at the time set by this paramter.

1. Enter the Start cycle by clock screen. The following screen will appear:



On the Start cycle by clock screen, the time is displayed in the form "HH:MM". The hour range is 24 hours (i.e. from "0" to "24").

### **Setting the time to start the cycle**

1. Move the cursor to the Time field.
2. Set the required time .

### **Enabling the Start Cycle by Clock**

1. Set the starting time .
2. Move the cursor to Enabled. Press Up or Down key to enable starting cycle by clock.



1. Exit the Enabling the Start Cycle by Clock. The start cycle by clock icon appears on the display:

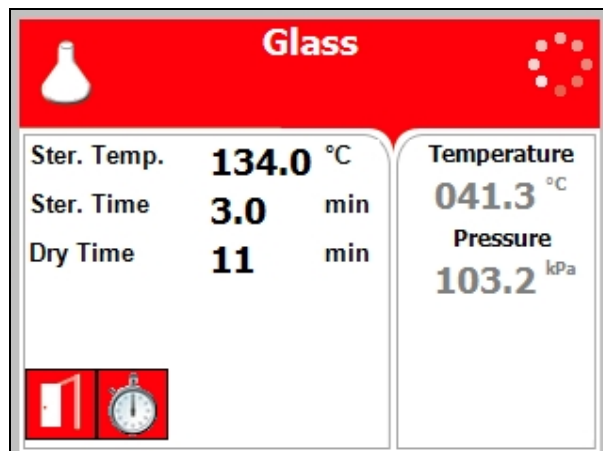

### **Disabling the START CYCLE BY CLOCK**

2. On the Start Cycle by Clock screen, move the cursor to Disabled. Press Up or Down key to disable Starting cycle by clock.
3. Exit the Enabling the Start Cycle by Clock.

### ***Set date and time***

This subdirectory enables the operator to set date and time.

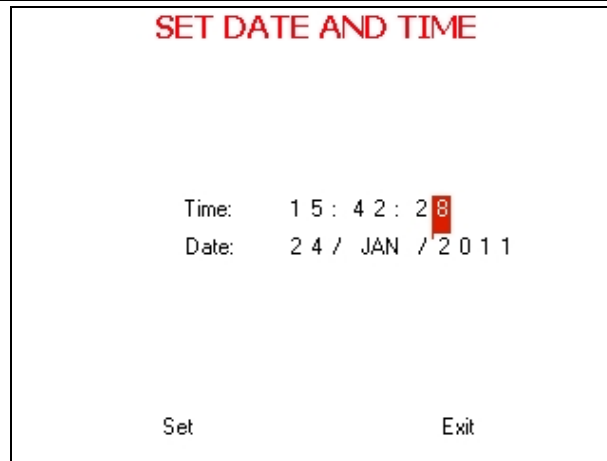

On the Set date and time screen, the time is displayed in the upper row in the form "HH:MM:SS". The hour range is 24 hour (i.e. from "0" to "24"). The date is displayed in the lower row in the form "DD: MMM: YYYY".

1. Set time and date
2. Exit the Set date and time screen. The following screen will appear:



**Caution!**

**After setting time and date, turn the autoclave off and then on again.**

#### **7.4 Logging in and entering the Main menu**

Below you can find instructions how to login and enter the Main menu. Section 9.1 above explains how to browse through the menus, section 9.2 explains how to change a parameter.

When the autoclave is on and no cycle is running, press the up and down keys simultaneously to enter the *Quick Options* screen (see 9.3). On this screen you can either proceed to login (see below) or choose one of the quick options available without login. To login as user:

1. On the Quick Options screen, choose login.

Select user screen appears.



2. Choose User, then press the Start/Stop key to enter. The following screen will appear:

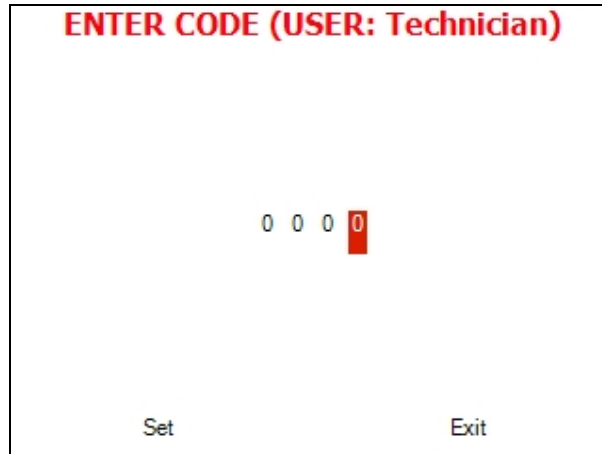

0000 is displayed on the screen with the cursor flashing on the right digit.

- Set the code to 0001. You will get to the Main menu.

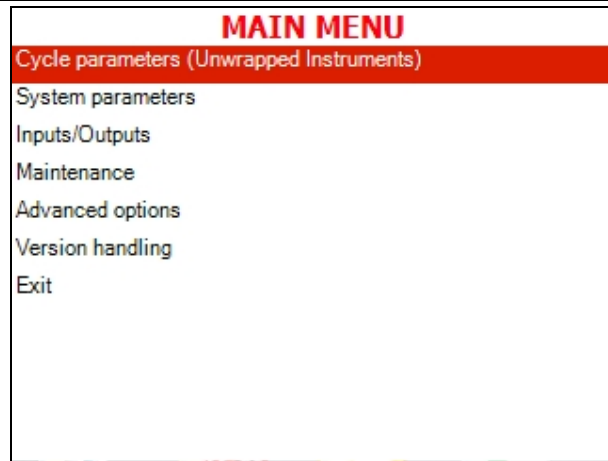

Below is the list and the explanation of some options available to user on the Main Menu.

### 7.5 Changing parameters

Bacsoft control panel provides an interface that consists of control screens available through an easy scrollable menu tree.

**To learn how to scroll through the menus, change the parameters, and perform some other functions using our three-button keypad, see 9.1 and 9.2.**

Below is the typical parameter changing screen:

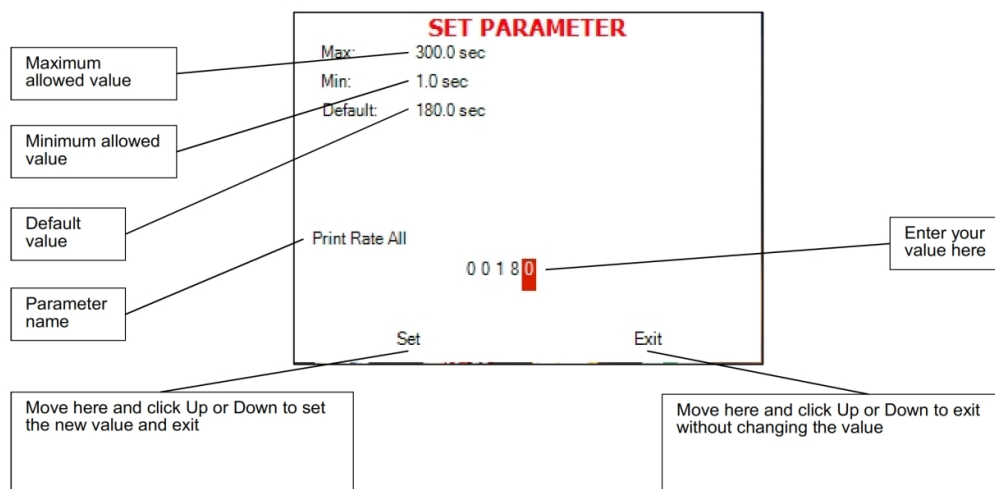

## 7.6 System Parameters

This menu is listing the system parameters that are the same for all cycles. Browse to the following folder:

Main menu\System parameters

You will see the following screen:

<b>SYSTEM PARAMETERS</b>	
Print Rate All	180.0 sec
Print Rate Sterilization	60.0 sec
Screen Saver	90.0 min
Pressure Calibration High	300.0 kPa
Pressure Calibration Low	25.0 kPa
Temperature Calibration High	130.0 °C
Temperature Calibration Low	60.0 °C
Cycle Print Gap	2.0
Exit	

### Screen Saver

In this menu you can define the screensaver delay time, i. e. how long the keyboard will be untouched before the screensaver activates.

Browse to the following folder:

System parameters\Screen Saver

Change the parameter as desired.

## 7.7 Maintenance

Maintenance procedures provided by *Bacsoft* software allow you additional tests and USB input/output options.

Browse to the following folder:

Main menu\Maintenance

You will see the following screen listing the maintenance options:

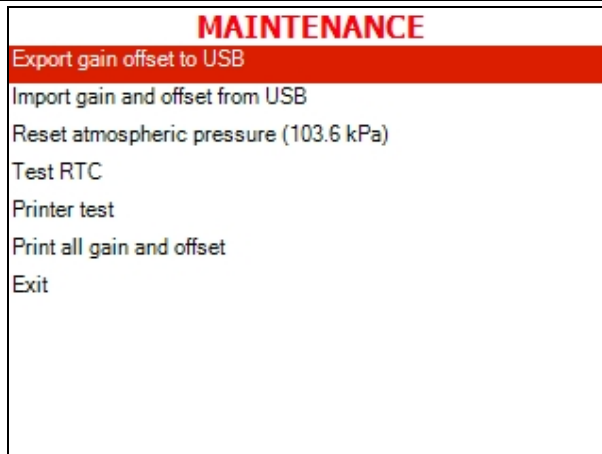

Below is the instruction for autoclave's maintenance menu.

### ***Reset atmospheric pressure***

In this menu you can reset the atmospheric pressure value. To do so:

1. Browse to the following folder:

Maintenance\Reset atmospheric pressure

The following screen will appear:



2. Leave the door open for 2 minutes at least. Ambient temperature should be less than 45°C.

**Note:** Please reset the atmospheric pressure when you install the autoclave for the first time, and each time you relocate or calibrate the autoclave.

### ***Printer test***

In this menu you can check the normal function of the printer. The printer will print the list of errors.

Browse to the following folder:



## Maintenance\Printer test

The following screen will appear to confirm that the test has been done.



See the printout shown in the Printer handling chapter of the user manual.

### 7.8 *Cycle parameters*

The Cycle parameters menu includes parameters of a specific sterilization program (cycle). Browse to the following folder:

Main menu\Cycle parameters

You will see the following screen listing the cycle parameters:

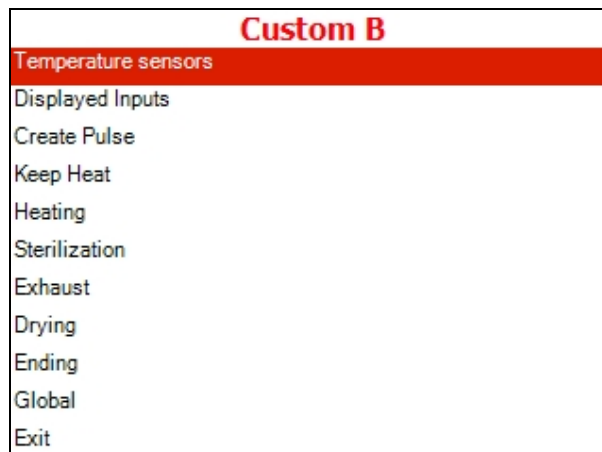

**Note:** For all the standard sterilization cycles, and for Bowie and Dick test, the only changeable cycle parameter is dry time (you will not see other parameters on your screen). For the custom cycles created by duplication, and for the

Warm Up cycle, more options are changeable. Operator is not allowed to create custom cycles; only authorized technician can do this.

### ***Dry Time***

This parameter defines duration of the drying stage for the cycle.

1. Browse to the following folder:

Cycle parameters\Drying\Dry Time

2. Change the parameter as desired.

Drying stage is divided into two stages. For each stage you can set the total time, on time and off time. So during the Dry First Stage, the heating elements are on for the time set in Dry Heat On 1, then they go off for the time set in Dry Heat Off 1, and then this sequence is repeated during the entire Dry First Stage Time. The same is true for the Dry Second Stage.

### ***Add Dry Time***

This subdirectory allows you to change the Dry Time parameter for the current cycle.

Browse to the following folder:

Cycle parameters\Drying\Add Dry Time

Change the parameter as desired.

## 8 **PRINTER**

### 8.1 **Printer Output**

The printing is on thermal paper with 24 characters per line and contains the following information:

- Date:
- Time:
- Ser. Num:
- Model:
- Version:
- Cycle Num:
- Cycle:
- Dry Time:
- Ster Temp:
- Ster Time:

When the sterilization cycle begins the printer starts printing the above data.

After the preliminary printing, the autoclave starts performing the sequence of operations of the cycle. The measured values of temperature and pressure are printed at fixed time intervals, according to the phase of the process, as shown in the table on the next page.

The data is printed from the bottom up, beginning with the date and ending with "Cycle Ended". For an aborted cycle, "Cycle Failed" and the Error message are printed (refer to "Displayed Error Messages/Symbols").

For an example of a typical printout, see next page.

Note: Please note that the print out goes from the bottom upwards.

PRINTER OUTPUT			DESCRIPTION
Operator:			To be filled in manually by operator
Time:	12:14:47		Time sterilization cycle ended
Status: Cycle Ended			
00:24:43	101.3	099.7	Cycle finished time
D 00:27:40	107.0	107.4	The time, temperature and pressure during Drying Stage
D 00:35:12	107.0	107.4	The time, temperature and pressure during Drying Stage
D 00:32:32	107.0	107.4	The time, temperature and pressure during Drying Stage
D 00:28:22	107.0	107.4	The time, temperature and pressure during Drying Stage
D 00:26:45	107.0	107.4	The time, temperature and pressure during Drying Stage
D 00:23:01	107.0	107.4	The time, temperature and pressure during Drying Stage
E 00:23:43	107.0	107.4	The time, temperature and pressure during exhaust
E 00:22:08	134.5	311.9	The time, temperature and pressure during exhaust
CLK 2:	12:12:10:00		Sterilization Process End time as registered by two clocks
CLK 1:	12:12:10:00		
S 00:22:07	134.5	311.6	The time, temperature and pressure during sterilization
S 00:22:06	134.5	311.6	The time, temperature and pressure during sterilization
S 00:21:06	134.6	311.0	The time, temperature and pressure during sterilization
S 00:20:06	134.5	310.1	The time, temperature and pressure during sterilization
S 00:19:06	134.8	311.1	The time, temperature and pressure during sterilization
S 00:18:06	134.5	315.8	The time, temperature and pressure during sterilization
CLK 2:	12:08:08:00		Sterilization Process Start time as registered by two clocks
CLK 1:	12:08:08:00		
H 00:18:04	134.4	315.1	The time, temperature and pressure during heating
H 00:16:35	128.9	268.4	The time, temperature and pressure during heating
H 00:13:35	116.3	180.9	The time, temperature and pressure during heating
A 00:11:04	107.0	162.9	The time, temperature and pressure during Air removal
A 00:10:22	115.1	200.4	The time, temperature and pressure during Air removal
A 00:10:00	113.7	162.5	The time, temperature and pressure during Air removal
A 00:07:00	098.7	200.5	The time, temperature and pressure during Air removal
A 00:06:45	097.6	165.4	The time, temperature and pressure during Air removal
A 00:03:45	080.2	200.4	The time, temperature and pressure during Air removal
A 00:00:45	053.7	154.4	The time, temperature and pressure during Air removal
A 00:00:04	046.5	097.0	The time, temperature and pressure during Air removal
W 00:00:05	029.3	096.0	The time, temperature and pressure during Water inlet
<b>TIME</b>	<b>°C</b>	<b>kPa</b>	
End Temp:	120.0 °C		
Ster Time:	4.0min		Sterilization time for selected program
Ster Temp:	134.0°C		Sterilization temperature in chamber for selected program
Cycle:	Glass		Cycle name
Cycle Num:	000001		Cycle number
Version:	1.0.00.00		Version A.B.CC.DD = 1.0.00.00 A: Door Type: Single Manual = 1 B: Vacuum Type = 0 C: Total number of Input/Output functionality that are not as default = 00 D: Total number of parameters values that are not as default = 00
Model:	5050ELPV-MD		Model name
Ser. Num:	000000000001		Model Serial number
Time:	11:50:05		Time sterilization cycle started
Date:	9/FEB/2010		Date sterilization cycle started
-----			
Time:	08:51:39		Time of turning on
Date:	9/FEB/2010		Date of turning on
POWER ON			The device is turned on
Time:	00:00:00		Time of turning off
Date:	9/FEB/2010		Date of turning off
POWER OFF			The device is turned off

Legend			
W	Insert Water	CLK 1	Real Time Clock
A	Air removal stage	CLK 2	Software clock
H	Heating stage	E	Exhaust stage
S	Sterilization stage		
D	Drying Stage (PV Model only)	C	Cooling stage (for VC only)

## 8.2 Printer Handling

### Maintenance

Wipe off the soiling on the printer surface with a dry soft cloth with a weak neutral detergent. After that, wipe the printer with a dry cloth.

### Setting paper

#### PLUS II Front view

- 1-Paper mouth
- 2-STATUS Led
- 3-OPEN key (for paper roll compartment opening)
- 4-FEED key
- 5-Paper roll compartment
- 6-Paper end sensor

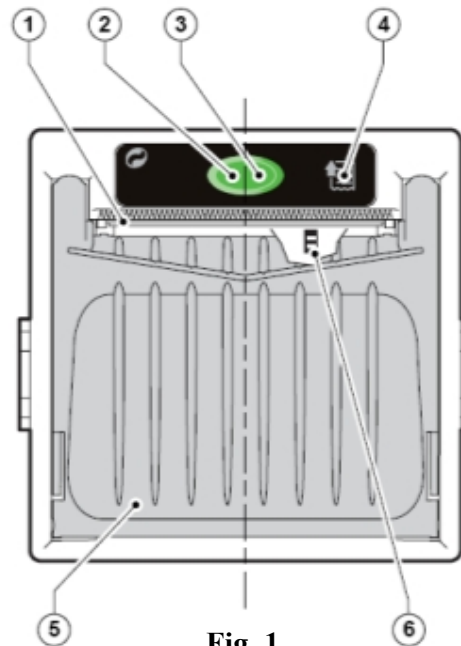

**Fig. 1**

1. Open the printer's cover door (1) by pulling it up (see Fig. 2).

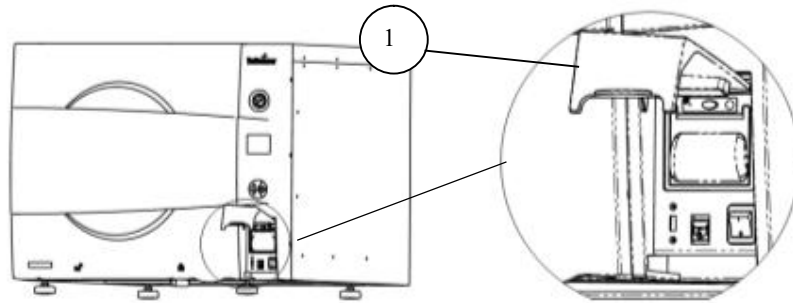

**Fig. 2**

2. Press the OPEN key to open the printer cover as shown (see Fig. 3/1). Handle the paper cutter carefully not to cut your hand.
3. Place the paper roll making sure it unrolls in the proper direction as shown (see Fig. 3/2).
4. Take out the paper and re-close the cover as shown (see Fig. 3/3) the printer cover is locked.
5. Tear off the exceeding paper using the jagged edge (see Fig. 3/4).

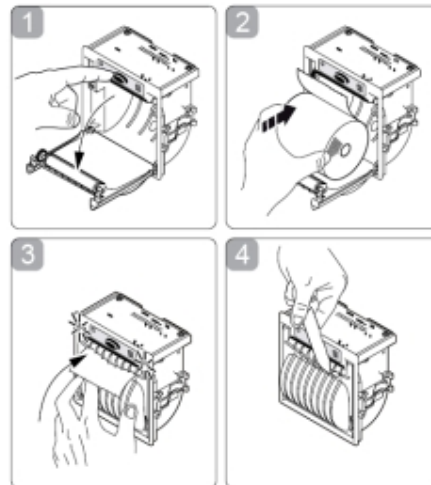

**Fig. 3**

6. Close the printer's cover door (1) by pulling it down, with the tip end of the paper emerging from the slot (2) (see Fig. 2).

---

**8.3 Treating the thermal papers:**

- Store the papers in a dry, cool and dark place.
- Do not rub the papers with hard substance.
- Keep the papers away from organic solvent.

**Cautions**



**Never disassemble the printer. Failure to follow this instruction may cause overheating or burning of the printer or the AC adapter. Or an electric shock, which may lead to fires or accidents.**

**Never use the printer in a place of extreme humidity or any place where it can possibly be splashed by any liquids. If any liquids get into the printer, it could lead to fire, electric shock, or other serious accidents.**

**Never touch the thermal head immediately after printing because it becomes very hot. Make sure that the thermal head is cool before setting papers or cleaning the thermal head.**

**Power OFF the printer in any of the following cases:**

- The printer does not recover from an error.
- Smoke, strange noise or smells erupt from the printer.
- A piece of metal or any liquid touches the internal parts or slot of the printer.

## 9 **PREPARATION BEFORE STERILIZATION**

The purpose of packaging and wrapping of items for sterilization is to provide an effective barrier against sources of potential contamination in order to maintain sterility and to permit aseptic removal of the contents of the pack. Packaging and wrapping materials should permit the removal of air from the pack, penetration of the sterilizing water vapor into the pack and removal of the sterilizing vapor.

The basic principle determining the size, mass and contents of instrument and hollowware packs is that the contents are sterile and dry immediately on completion of the cycle and removal of the pack from the sterilizer chamber.

Instruments to be sterilized must be clean, free from any residual matter, such as debris, blood, pads or any other material. Such substances may cause damage to the contents being sterilized and to the sterilizer.

1. Before use, check inside the autoclave chamber to ensure that no items have been left from the previous cycle.
2. Immediately after use, clean instruments thoroughly to dispose of any residue.
3. It is recommended to wash instruments with an ultrasonic cleaner, using detergent and mineral-free water.
4. Launder textile wraps prior to reuse.
5. After cleaning, rinse instruments for 30 seconds. (Follow manufacturer's instructions on the use of products for cleaning and lubricating instruments after using the ultrasonic cleaner).
6. Materials, including materials used for inner wraps, shall be compatible with the item being packed and the sterilizing method selected.
7. Do not place materials to be sterilized directly on the chamber's wall. Place the material only on trays, rack, etc.

### 9.1 **Instruments**

8. Before placing an instrument on the sterilizer tray, make sure that instruments which are not of the same metal, (stainless steel, carbon steel, etc.) are separated and placed on different trays.
9. Place empty containers upside down to prevent accumulation of water.

**Note:**

**Check manufacturer's instructions for the sterilization of each item.**



10. In case carbon steel instruments are placed on the stainless steel tray, the tray should be lined with a towel or paper wrap before placing the instruments on the tray. There should be no direct contact between the carbon steel and the stainless steel tray.

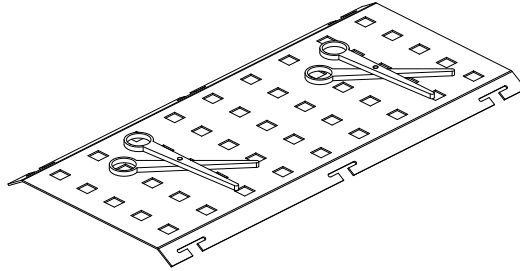

11. All instruments must be sterilized in an open position.
12. Use single-use wraps once only and discard after use.
13. Place a sterilization indicator strip on the tray.
14. Place instruments with ratchets opened and unlocked or clipped on the first ratchet position.
15. Disassemble or sufficiently loosen multiple-part instruments prior to packaging to permit the sterilizing agent to come into contact with all parts of the instrument.
16. Tilt on edge items prone to entrap air and moisture, e.g. hollowware, so that only minimal resistance to removal of air, the passage of steam and condensate will be met.
17. Load items within the boundaries of the tray so that they do not touch the chamber walls.
18. The operator may use racks to allow for adequate separation of packaged instruments.
19. Load trays in such a way as to allow steam to move freely among all items.
20. Once a week, use a biological spore test indicator in any load to make sure sterilization is performed efficiently.
21. Make sure that all instruments remain apart during the sterilization cycle.
22. Empty canisters should be placed upside-down, in order to prevent accumulation of water.

### 9.2 **Tubing**

- When placing tubing on the tray, make sure that both

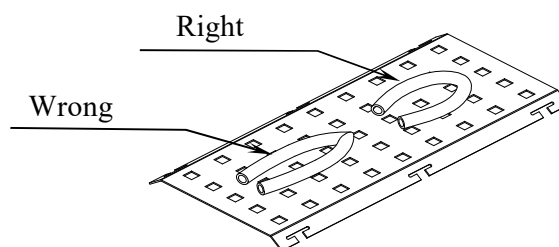

ends are open, without sharp bends or twists.

### 9.3 **Sterilization of Liquids**

1. Use only heat-proof glass, filled 2/3 full.
2. Ensure that the glass container is covered but not sealed to prevent pressure build-up.
3. Place the two temperature sensors into two separate liquid containers. These are used to control the program temperature and ensure the safety of the operating cycle.

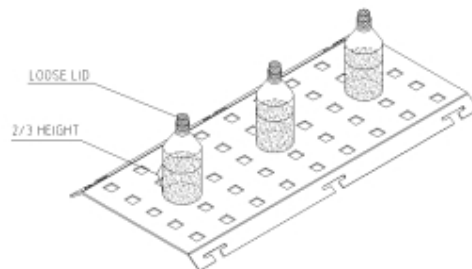

#### **Note:**

For isothermal cycles, insert one PT100 temperature sensor into the liquid, and allow the other PT100 temperature sensor to hang loose inside the chamber, (see the figure below). For proper sterilization, ensure all the bottles are filled with approximately the same amount of liquid.



### 9.4 **Filling the Water Reservoir**

Remove the water reservoir cover. Pour distilled water into the reservoir through the opening on top of the autoclave until it reaches the level of approximately 1÷2 cm (0.5"÷0.75") below the outlet of the return tube. The water quantity is 16÷17 liters (4.2÷4.5 US gal).

Use only water having the characteristics as per table in para. 3.17.1 Tap water may clog the system. A clogged system causes increase of pressure, which prevent temperature from rising.



**Caution!**  
**Under no circumstance should water be filled above the level defined above.**

## 10 OPERATING INSTRUCTIONS

### 10.1 Turning on the autoclave

- To start the system, turn on the main switch (1), located under the printer cover.

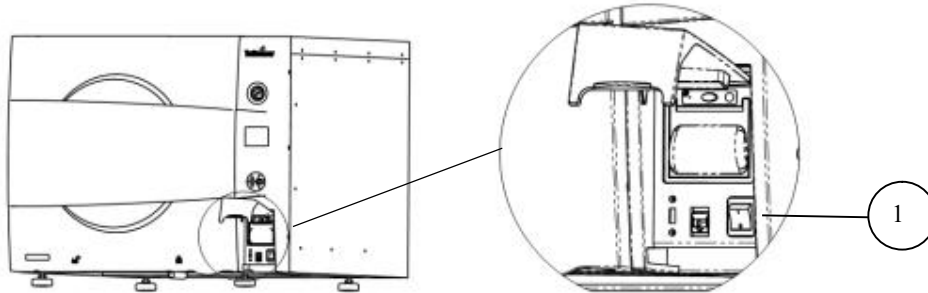

The door is equipped with an electrical cylinder. This electrical cylinder performs the automatic opening and closing of the door.

### 10.2 Opening the door – MD models (mechanical door)

- Move the door handle (1) from position "locked" (2) to position "unlocked" (3).
- Open the door.



### 10.3 Opening the door – D models (automatic door)

In order to open the door, follow the next steps:

1. When the door is closed the screen below will be displayed:

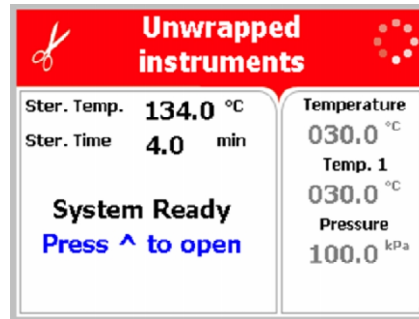

2. Press the UP Key in order to open the door

The following screen will be displayed:

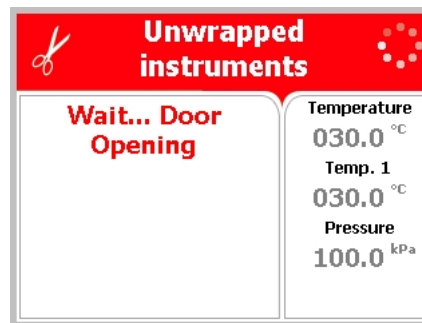

If the door has opened successfully, the following screen will be displayed:

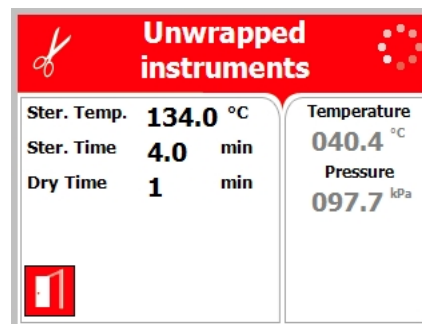

#### 10.4 Safety

Protective equipment and clothes and other safety instructions should be implemented in accordance with local and national regulations and/or rules!

For proper sterilization - Do not overload the chamber. Only autoclavable products shall be used; please refer to the manufacturer instructions for sterilization of unknown materials or instruments.

### 10.5 Loading

Correct loading of the autoclave is essential to successful sterilizing for several reasons. Efficient air removal from the chamber and the load will permit total steam penetration and saturation, and allow proper drainage of condensate. Additionally, correct loading will reduce damage to packs and their contents and maximize efficient use of the sterilizer. For detailed loading instructions, see para. 9 (Preparation before sterilization)

### 10.6 Selecting the Program

1. Select the program.
  - **UP** key: next program.
  - **DOWN** key: previous program.
2. Make sure Verify that you chose the required program.
3. If the autoclave is equipped with a printer verify that a paper roll is inserted in the printer. If not - insert as per para. 5.2.



**Attention:**

**Selecting a program is possible only when the door is open.**

### 10.7 Closing the door – MD models (mechanical door)

1. Close the door.
2. Move the door handle (1) from position "unlocked" (3) to position "locked" (2).
3. The open door symbol  is replaced by the message "System Ready".

### 10.8 Closing and locking the door – D models (automatic door)

In order to close the door, follow the following steps:  
When the door is open, the screen below will be displayed:

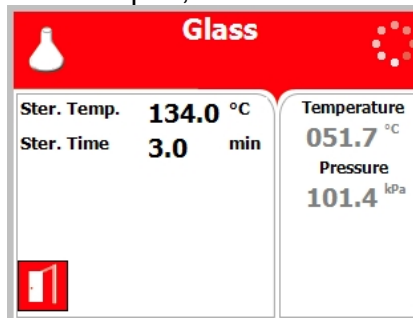

1. Close the door:





**Warning!**

In order to close and lock the door push the door to the wall of the autoclave chamber (for about 10 seconds) until the "System Ready" message appears as shown below!

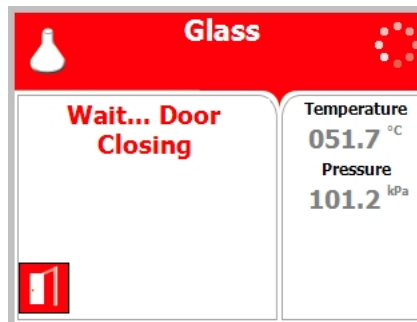

While the door is locking the following screen will be displayed:



When the door is properly locked, open door symbol  will be replaced by the "System Ready" message as shown below:

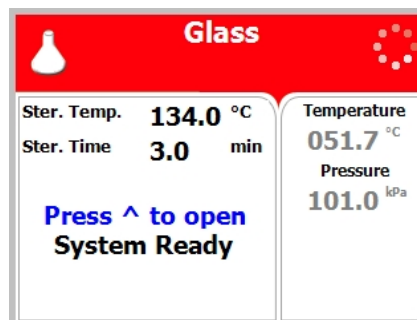

**10.9 Starting cycle**

1. Start the cycle by pressing the START/STOP key.

The autoclave starts performing sequence of operations. The actual measured values of pressure and temperature are displayed continuously and printed every minute at STE stage, and every 5 minutes at the other stages. The phase in progress is displayed at the right side of the upper line as WATER, HEAT, STER., EXH., and DRY.

If the operator presses the START key and the door is not completely closed, the process will not start and the DOOR indicator will flash twice then turn off and the buzzer will sound four times.



**Caution!**

**Do not touch the strainer's cover, mounted on the exhaust line, during and short after operation.**

**Touching the hot strainer's cover may cause severe injuries.**

### **10.10 Unloading**

1. When the cycle ended, press START/STOP key to verify the status. Message "Cycle Ended" (and the relevant failure message, if applicable) is displayed on the screen.
2. Verify that there is no pressure in the chamber, according to the reading on the display. Only then you may open the door.
3. Open the autoclave. (see sec. 11.2 Opening the door)



**Warning!**

**To avoid sever injuries from hot steam when opening the door:**

**It is strictly forbidden to lean on the autoclave.**

**It is strictly forbidden to place your hand or any part of your body over the door.**

**Wear heat-resistant gloves or use the tray handle to remove the load from the autoclave**

**To avoid severe injuries from hot steam when opening the door:**

**It is strictly forbidden to lean on the autoclave.**

**It is strictly forbidden to place your hand or any part of your body over the door.**

**Since the autoclave is defined as a bio-hazard autoclave, a failed cycle may leave un-sterilized waste in the chamber. Therefore failed cycle will be followed by a slow exhaust and the door will remain locked. To enable opening the door perform a new cycle. The door can be opened only after a successful cycle.**



4. To release the door locking at the end of operation, press the UP key. The same applies at power up after fail. For MD models, rotate the handle counter-clockwise to pull out the locking arms handle from the retaining brackets.
5. Wear heat-resistant gloves or use the tray handle to remove the load from the autoclave
6. On completion of the cycle, the load shall be visual inspected to ascertain that the load is dry, and that the colour of the sterilization indicators turned to the required color.
7. At the end of each working day close the main water valve.

#### ***10.11 Start Cycle by Clock mode***

1. This mode enables the operator to define the time of the beginning of the cycle. The maximum possible delay is 24 hours.

## 11 SERVICE AND MAINTENANCE INSTRUCTIONS

### 11.1 Preventive and Scheduled Maintenance

The maintenance operations described in this chapter have to be fulfilled periodically to keep the device in good condition and to reduce the breakdown time to a minimum.

The user maintenance personnel can easily execute these operations in accordance with further instructions.

The owner of the autoclave is responsible to order an authorized technician to perform the periodical tests and preventive maintenance operations, as specified in the technician manual.

Use only mineral-free water as detailed in para. 2.13 (water quality).

#### **Warning!**

**Before carrying out any preventive maintenance operation, ensure that the electrical cord is disconnected and that there is no pressure in the autoclave.**



#### **Daily**

Clean door gasket with a soft cloth. The gasket should be clean and smooth.

#### **Weekly**

1. Once a week clean and descale the chamber, copper tubes and the reservoir.



#### **Caution**

**Do not use steel wool or steel brush as this can damage the chamber!**

2. Put a few oil drops on the 2 door pins and door tightening bolt.
3. Clean the outer parts of the autoclave with a soft cloth.
4. Once a week, or after 20 cycles (whichever comes first), drain the water from the reservoir, and refill with fresh mineral-free water or distilled water (see para. 9.2).
5. Clean the electrode with a soft cloth.

#### **Periodically**

1. On C models replace the air filter, every 6 months (to be performed by a technician).
2. Check the door gasket every 12 months and replace it if required (see para. 9.5). Replacing the gasket shall be done by a technician.
3. Once a year check and tighten the piping joints to avoid leakage.
4. Once a year check and tighten all screw connections in the control box, heaters and valves and instrumentation.

5. Once a month clean the strainer as per para. 9.3. Cleaning frequency may be reduced according to experience.
6. Once every six months clean the fan grid, from the inside outward, with a vacuum cleaner.

### **Periodical Tests**

1. Once every month activate the safety valve (see para. 9.4).

#### **11.2 Draining the Reservoir**



#### **Caution!**

**Before starting, Make sure that the electric cord is disconnected and there is no pressure in the autoclave.**

1. Connect the supplied plastic tube and turn drain valve counter clockwise (1 turn).
2. When the water reservoir is empty, turn drain valve clockwise to the clockwise position. Remove the plastic tube.
3. Fill reservoir with distilled water until it reaches the base of the safety device holder (for water quantity, refer to tables on paragraphs 2.9, 2.10).
4. Connect the electric cord to power source.

The autoclave is now ready for use.

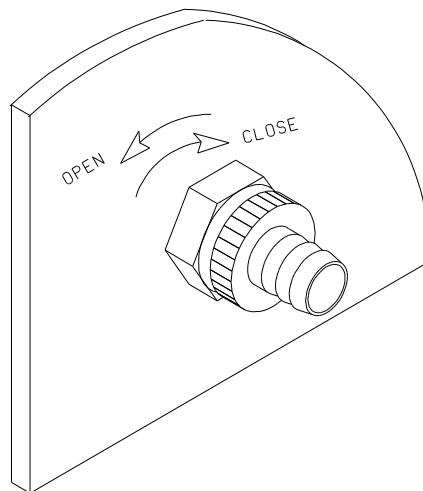

### 11.3 *Cleaning water strainer*



**Caution!**

**Before proceeding, Make sure that the electric cord is disconnected and there is no pressure in the autoclave.**

1. Open the strainer cover.
2. Remove the strainer element.
3. Rinse the strainer with water. Use a brush if necessary.
4. Reinstall the strainer element.
5. Close the strainer cover.



**Caution!**

**Do not touch the strainer's cover, mounted on the exhaust line, during and short after operation.**

**Touching the hot strainer's cover may cause severe injuries.**

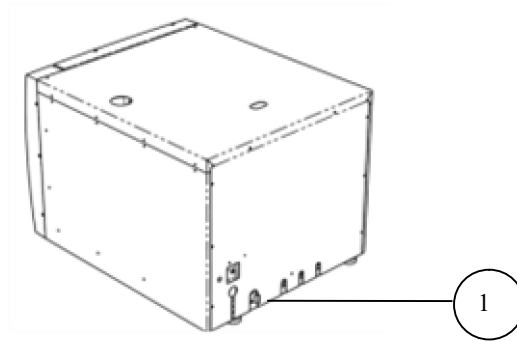

No.	Description
1	Strainer

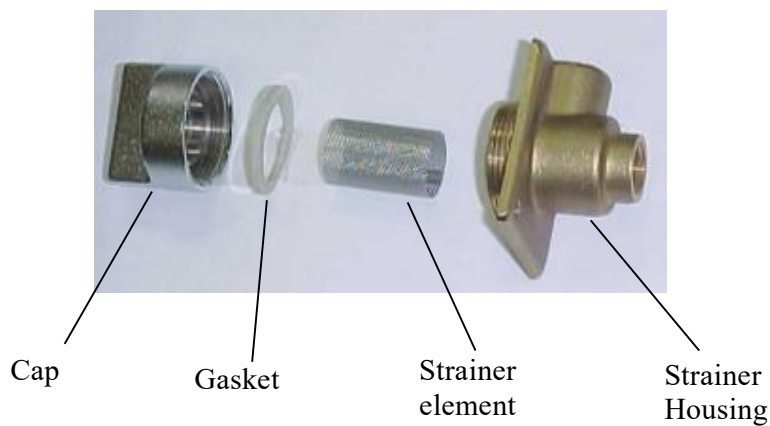

## 11.4 Checking the Safety Valve

In order to prevent the safety valve from blockage, it is necessary to allow the steam pressure to escape through it (every month).

The safety valve is located in the rear top side of the autoclave.

### ***PED-approved type safety valve***

1. Operate the sterilization cycle according to the manual.
2. Allow a pressure of approx. 200 kPa (29-psi) to build up in the chamber.
4. Turn the pressure relief nut counterclockwise for 2 seconds. Verify steam escapes from the valve.



#### **Attention:**

**Use protective gloves in order not to burn your hands with the hot steam.**

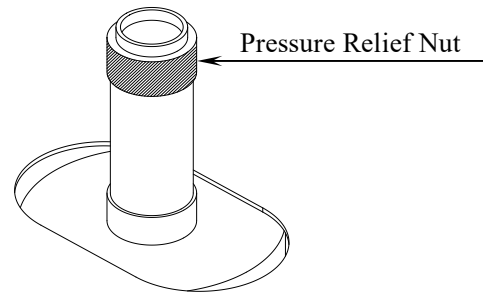

5. Press the STOP key to interrupt the operation, and exhaust steam from the chamber.
6. Wait until the pressure decreases to zero, only then can the door be opened.

### ***ASME-approved type safety valve***

1. Operate the sterilization cycle according to the manual.
2. Allow a pressure of approximately 200 kPa (29-psi) to build up in the chamber.
3. Remove water reservoir cover
4. Operate the safety valve:
5. Pull the valve's handle and verify that steam escapes from the valve.

6. Press the STOP key to pause operation, and exhaust steam from chamber.
7. Wait until pressure goes down to zero, only then can the door be opened.



**Attention:**  
Use protective gloves in order not to burn your hands with the hot steam.

8. Press the STOP key to interrupt the operation, and exhaust steam from the chamber.
9. Wait until the pressure decreases to zero, only then can the door be opened.

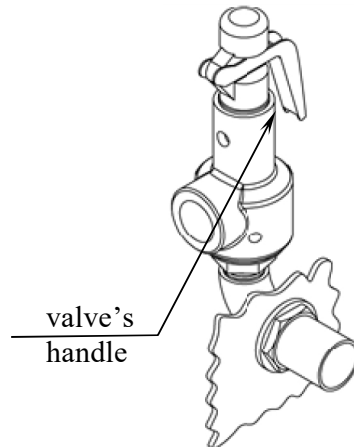

#### **11.4.1.1 Safety opening device (11)**

This Safety device is a 3/2 operating pneumatic spring loaded valve (2 position, 3 ports) that is connected to the safety port of the door. An angular bracket (12), which is attached to one of the arms, will push the valve's piston to a position that at the instant that the arms are locked, the safety port of the door is blocked.

At the instant that the arms moves backward the valve changes its position and the chamber is vented. After the pressure in the chamber equalizes the ambient pressure the autoclave's door can be opened with no risk for the operator, of steam or hot water burst.

### **11.5 Moving the Autoclave**

1. Disconnect the power supply cord.
2. Disconnect the water and drain hoses.
3. Disconnect the compressed air hoses (if applicable).
4. Drain the water from the chamber.

**To avoid injuries, Moving the autoclave should be done by using a forklift.**



**Caution:**

**Before moving the autoclave, verify that the electrical, air and water connections have been disconnected, and there is no pressure in the chamber.**

**Do not drop this device!**

## **12 Safety Process Description**

1. The user closes the door and rotates the handle clockwise approx. 90°
  - a. At the end of the circular movement of the arms holder, the pin of the locking solenoid slides to its locking position.
  - b. When the arms moves the last radial 15 mm, one arm activate the microswitch, while another arm (on which there is the angular bracket) pushes the piston of the 3/2 valve to a position that the venting port of the door is blocked.
2. The user start a sterilization cycle by pressing a “start” key on the operating panel.
3. Cycle completion.

There are 6 sterilization programs:

- a. Program 1 and 2 will end if the cycle is completed and the pressure in the chamber is below 115 kPa (abs).
- b. Programs 3 to 6 will end if the cycle is completed, the pressure decreases below 115 kPa (abs) and the chamber temperature decreases below 90°C.

### **12.1 DOOR SAFETY SYSTEM – D models (automatic door)**

Door closing: the user pushes the door towards the chamber frame, a switch located on the frame indicates that the door is in locking position and switches on an electrical cylinder that closes and locks the door. Two micro switches indicate that the door is locked, and stops the command to the electrical cylinder.

Door opening: The user presses a key to open the door. The control system operates the electrical cylinder that unlocks the door. When the door is unlocked, a micro switch indicates that the door is unlocked and stops the electrical cylinder.

### **12.2 DOOR SAFETY SYSTEM – MD models (mechanic door)**

4. For MD models: After all completion conditions are fulfilled, the operator must rotate the handle a little bit counterclockwise to activate the microswitch (10).

Activating the microswitch will cause the “door” light to flash a few times.

When the first step of opening the door is performed and arms are unlocked turning the handle counter-clockwise, the arms



change direction, the piston is released and valve opens, chamber is aerated and residual pressure discharged from the chamber.

This way, the second step, opening the door by pulling it, can be done safely, with no risk for the operator, of steam or hot water burst.

After the "door light" had signaled the operator will press the "up" key and the solenoid will retract.

At this stage the unlocking operation is completed and the operator can open the door.

### **12.3 Pressure switch**

The autoclave is equipped with a NC 10 kPa (1.4 psi) pressure switch that is connected to the chamber. When the pressure switch senses pressure of 10 kPag (1.4 psig) it disconnects the electrical command of the electrical cylinder to avoid accidental opening of the door.



### 13 TROUBLESHOOTING

This troubleshooting chart enables the user to solve minor malfunctions, prior to contacting our service department.

Only technical personnel having proper qualifications and holding technical documentation (including a technician manual) and adequate information are authorized to service the apparatus.

<b>Problem/ Error Message</b>	<b>Message / Symbol Description</b>	<b>Corrective Action</b>
Display is not activated	<p>The on/ off switch is in the off position.</p> <p>The power cord is not connected properly to the machine and the power source.</p> <p>There is no electrical power in the main source.</p> <p>An input fuse has blown</p>	<p>Turn the on/ off switch on.</p> <p>Make sure the power cord is properly connected to the machine and the power source.</p> <p>Fix the electrical power supply.</p> <p>Call for service</p>
The printer does not print	<p>The paper is not inserted correctly in the printer.</p>	<p>Make sure the paper is inserted in the printer correctly (see <b>Error! Reference source not found.</b> ).</p> <p>Switch the machine off then back on. If the printer prints the date and time, the printer is O.K.</p>
"Analog Input Error"	<p>This message is displayed when any Temperature sensor or Pressure sensor is disconnected or out of range.</p>	<p>Call for service</p>
"Chamber temperature not in range"	<p>This message is displayed if the temperature in the chamber is too high or too low from the normal range.</p>	<p>Wait until the the chamber reaches the normal range temperature.</p>
"Chamber pressure not in range"	<p>This message is displayed if the pressure in the chamber is too high or too low from the normal range.</p>	<p>Wait until the the chamber reaches the normal range pressure.</p> <p>The atmospheric pressure parameter may need to</p>

<b>Problem/ Error Message</b>	<b>Message / Symbol Description</b>	<b>Corrective Action</b>
		be set.
"I/O Card Failed"	This message is displayed if I/O card is faulty (both while cycle is running or not).	Turn the autoclave off and on again. If the problem persists, call for service.
"I/O card is not connected"	This message is displayed if I/O card is disconnected (both while cycle is running or not).	Turn the autoclave off and on again. If the problem persists, call for service.
"Low Temp"	This message is displayed if the temperature drops for more than 1 second below the sterilization temperature during sterilization cycle.	Perform a new cycle.
"High Temp"	This message is displayed if the temperature raises 4°C above sterilization temperature during the sterilization stage for 2 seconds during sterilization cycle.	Perform a new cycle.
"High Temp. (Ending)"	This message is displayed if the system cannot reach the required temperature, in the chamber, within 10 minutes.	Perform a new cycle.
"Heat Time Error"	This message is displayed if the system cannot reach the required temperature, in the chamber, within the preset time.	Verify that the autoclave is not overloaded.
"Low Pressure"	This message is displayed if Chamber Pressure drops below the sterilization pressure for 2 seconds during the sterilization stage.	Perform a new cycle.
"High Pressure"	This message is displayed if Chamber Pressure raises 29 kPa above sterilization pressure for 2 seconds during the sterilization stage.	Perform a new cycle.
"High Pressure (Ending)"	This message is displayed if the system cannot reach atmospheric pressure $\pm 5$ kPa during the ending stage.	Perform a new cycle.
"High"	This message is displayed if the	Perform a new cycle.

<b>Problem/ Error Message</b>	<b>Message / Symbol Description</b>	<b>Corrective Action</b>
Pressure (Exhaust)"	system cannot reach preset pressure within 10 minutes from the beginning of the exhaust stage.	
"High Pressure (Dry)"	This message is displayed if the pressure in chamber exceeds atmospheric pressure by more than 10kPa at the beginning of the dry stage.	Perform a new cycle.
"Pressure Time Error"	This message is displayed if the system cannot reach the required pressure conditions in the chamber, after preset time, during the air removal stage.	Verify that the autoclave is not overloaded.
"RTC Error - Please Set Current Date and Time"	This message is displayed in order to set the date and the time.	Set Current Date And Time. If the problem persists, call the technician.
"Time Error"	This message is displayed if the real time clock is faulty.	Call for service.
"Door is open (During the cycle)"	This message is displayed when the door is open: During the cycle.	Close the door to perform a new cycle.
"Canceled By User"	This message is displayed after the START/STOP key is pressed and cycle aborted.	Wait until "cycle failed – canceled by user" or "cycle end – canceled by user" is displayed. Perform a new cycle.
"Cycle Failed" 	This message and symbol are displayed if an error occurs before sterilization cycle is completed.	Perform a new cycle.
"Test Fained" 	This message and symbol are displayed if an error occurs before test cycle is completed.	Perform a new test.
"Air Error"	This message is displayed at the end of the cycle if the autoclave does not reach the atmospheric pressure after 10 minutes.	Wait until the autoclave reaches the atmospheric pressure and perform a new cycle.
"Jacket is cool"	The message is displayed if, when pressing Start/Stop, the temperature of the jacket is below the preset temperature.	Wait until the jacket warms up.

<b>Problem/ Error Message</b>	<b>Message / Symbol Description</b>	<b>Corrective Action</b>
"Periodical check time exceeded - Please call for service"	The periodical maintenance time has passed.	Call for service.
"Mineral free water reservoir empty"	This message is displayed if the water level electrode does not sense water.	Fill the mineral free water reservoir.
"Cycle counter exceeded - Please call for service"	Number of cycles, since last periodical maintenance, exceeded the preset number as defined by "cycle counter" parameter.	Call for service.
"Power Down"	This message is displayed if power down has occurred during the cycle. (this message will print out in the printer after the autoclave will turn on).	Turn on the autoclave and wait until the autoclave is ready (reaches the safe condition) and perform a new cycle.
"No Water"	This message is displayed if the electrode in the chamber did not sense water within the preset time.	Check and fix the mineral free water supply. Check and clean the water inlet filter. Clean the water level electrode.
Low Vacuum' is displayed	Message is displayed and FAIL indicator lights if in the air removal stage a vacuum level of 15kPa is not reached during 20minutes after the cycle is started	<ol style="list-style-type: none"> <li>1 Perform a new cycle.</li> <li>2 Call the technician.</li> <li>3 The bio-hazard filter may be clogged. Since the door cannot be opened until a complete successful cycle is completed – call for technical service.</li> </ol>

## BASKETS AND CONTAINERS



**Basket**

**Container for waste products**

Model	Stainless steel wire baskets		Stainless steel container for waste products	
	L x D x H (mm)	Capacity	L x D x H (mm)	Capacity
<b>5050</b>	500 x 380 x 250	1	500 x 380 x 250	1
<b>5075</b>	715 x 380 x 250	2	715 x 380 x 250	2

## 14 SPARE PARTS LIST

<i>Description</i>	<i>Cat. No.</i>	
	<i>5050</i>	<i>5075</i>
Strainer element, 400µ	FIL175-0046	FIL175-0046
Cap for 1/4" strainer	FIL175-0027	FIL175-0027
Teflon gasket 4mm	GAS082-0008	GAS082-0008

## 15 ACCESSORIES LIST

<i>Description</i>	<i>Cat. No.</i>	
	<i>5050</i>	<i>5075</i>
Chamber Brite™ 1 box (10 packets)	CLE096-0026	CLE096-0026
Printer (DPU30)	THE002-0022	THE002-0022
Printer paper (DPU30)	THE002-0025	THE002-0025
Tray	TRY505-0001	TRY507-0001
Feed water hose for C models	GAS084-0001	GAS084-0001
Compressed air hose (C models)	GAS084-0002	GAS084-0002
Drain hose for C models	GAS084-0007	GAS084-0007
Container	BSK505-0001	BSK507-0008
Basket	BSK505-0002	BSK507-0010